

01 WALL TYPE - 3 5/8" PARTIAL HEIGHT
SCALE: 1" = 1'-0"

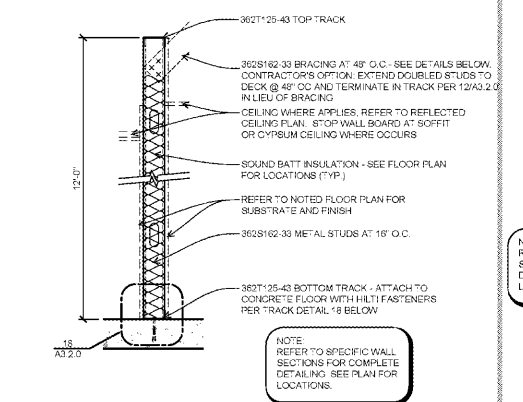

02 WALL TYPE - 3 5/8" PARTIAL HEIGHT
SCALE: 1" = 1'-0"

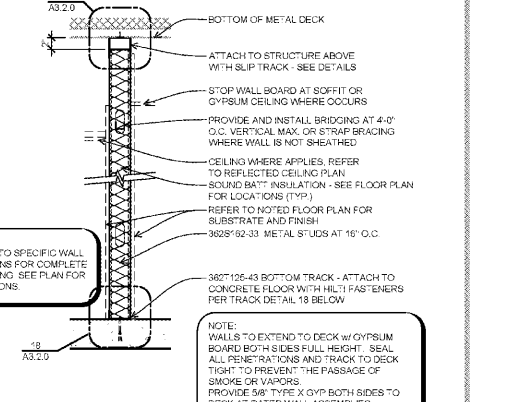

03 WALL TYPE - 3 5/8" TO STRUCTURE
SCALE: 1" = 1'-0"

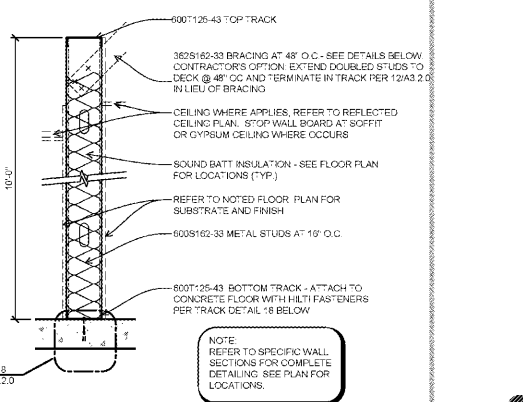

04 WALL TYPE - 6" PARTIAL HEIGHT INSUL.
SCALE: 1" = 1'-0"

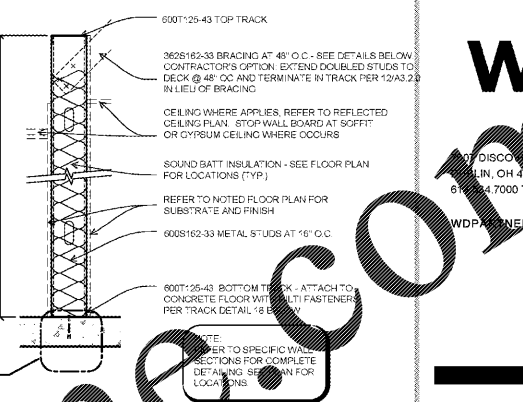

05 WALL TYPE - 6" PARTIAL HEIGHT
SCALE: 1" = 1'-0"

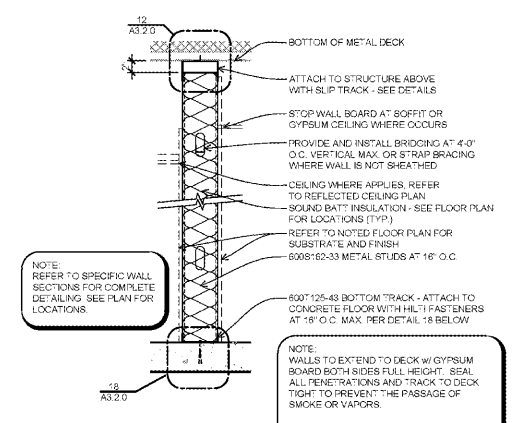

06 WALL TYPE - 6" TO STRUCTURE
SCALE: 1" = 1'-0"

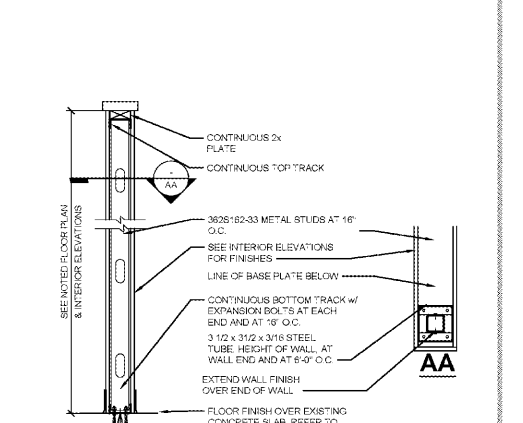

07 TYPICAL LOW WALL FRAMING
SCALE: 1" = 1'-0"

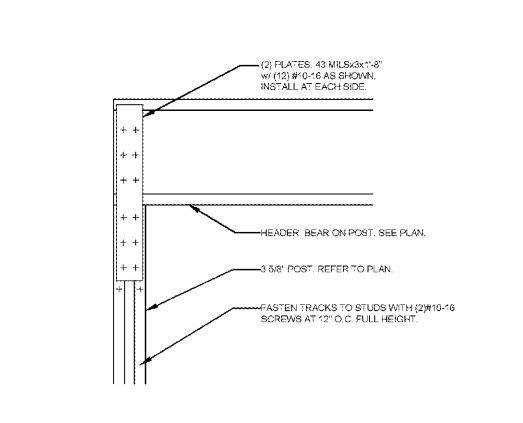

11 BEAM TO POST CONNECTION
SCALE: 1 1/2" = 1'-0"

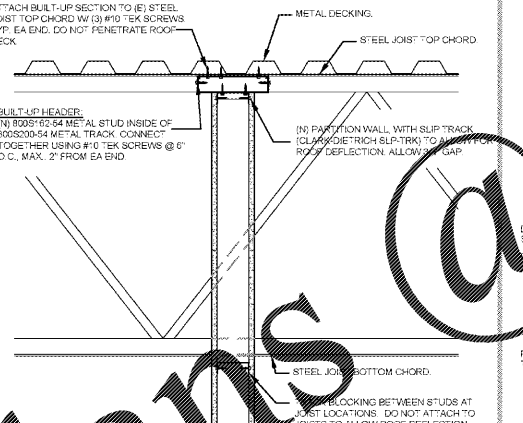

12 TOP OF PARTITION WALL CONNECTION
SCALE: 1 1/2" = 1'-0"

HEADER LENGTH	HEADER MEMBERS	MINIMUM EFFECTIVE PROPERTIES PER STUD
10'	12 3/4" x 18 GAUGE	$I_x = 2.32$ $S_x = 0.870$
10'	12 3/4" x 18 GAUGE	$I_x = 2.274$ $S_x = 0.858$
10'	12 3/4" x 14 GAUGE	$I_x = 3.284$ $S_x = 1.081$
10'	12 3/4" x 18 GAUGE	$I_x = 4.134$ $S_x = 1.083$
10'	12 3/4" x 18 GAUGE	$I_x = 3.110$ $S_x = 1.277$
10'	12 3/4" x 14 GAUGE	$I_x = 4.809$ $S_x = 1.570$
10'	12 3/4" x 14 GAUGE	$I_x = 2.335$ $S_x = 2.266$
10'	12 1/2" x 14 GAUGE	$I_x = 18.130$ $S_x = 7.234$
10'	12 1/2" x 18 GAUGE	$I_x = 18.575$ $S_x = 3.251$

13 HEADER DETAILS
SCALE: 1 1/2" = 1'-0"

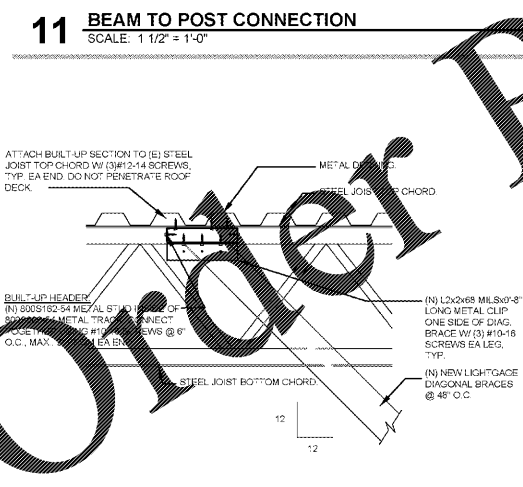

15 DIAGONAL BRACING CONNECTION
SCALE: 1 1/2" = 1'-0"

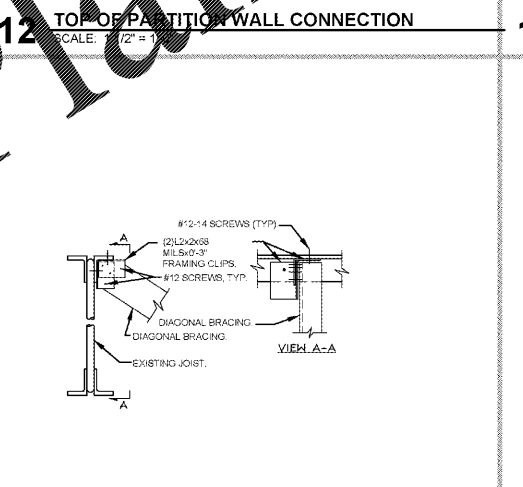

16 DIAGONAL BRACING CONNECTION
SCALE: 1 1/2" = 1'-0"

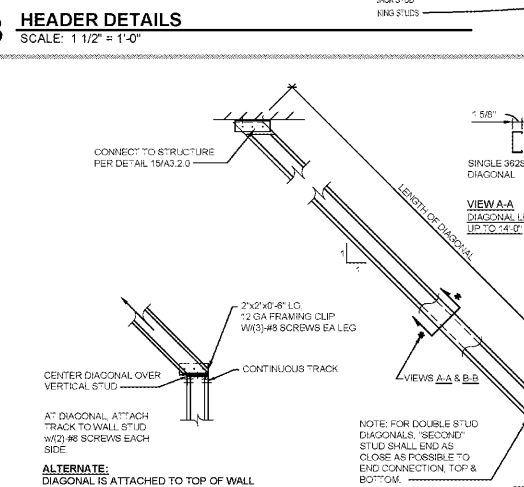

17 DIAGONAL BRACING DETAIL
SCALE: 1" = 1'-0"

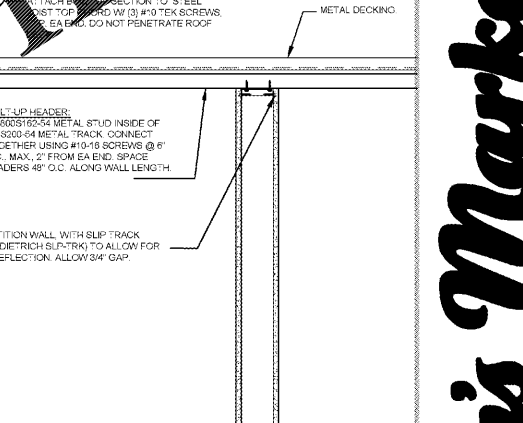

10 TOP OF PARTITION WALL CONNECTION
SCALE: 1 1/2" = 1'-0"

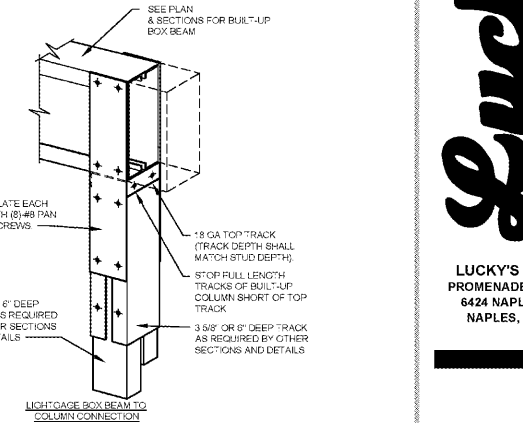

14 METAL STUD BOX COLUMN DETAIL
SCALE: 1" = 1'-0"

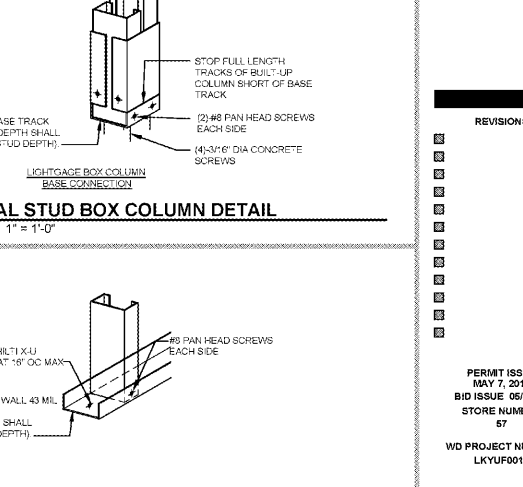

18 TYPICAL WALL STUD TRACK DETAIL
SCALE: 1" = 1'-0"

WWW.LDILLINE.COM

Order Plans @

wd

LUCKY'S MARKET

6424 NAPLES BLVD.
NAPLES, FL 34109

LUCKY'S MARKET
PROMENADE AT NAPLES
6424 NAPLES BLVD.
NAPLES, FL 34109

REVISIONS

PERMIT ISSUE
MAY 7, 2018
BID ISSUE 05/07/18
STORE NUMBER
57
WD PROJECT NUMBER
LKYU0011

A3.2.0

WALL TYPES AND DETAILS