

DOWEL SIZE AND SPACING			
SLAB DEPTH (T)	DOWEL DIAMETER	TOTAL DOWEL LENGTH (L)	DOWEL SPACING CENTER TO CENTER
N	N	N	N
4	3/4	16	24
5-6	3/4	16	12
7-8	1	16	12
9-11	1 1/4	18	12

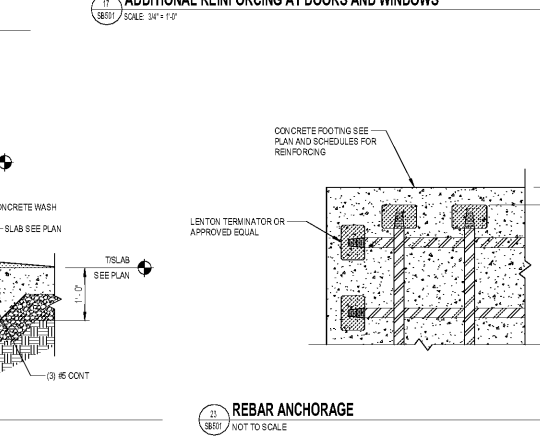

Revisions:

No.	Description	Date

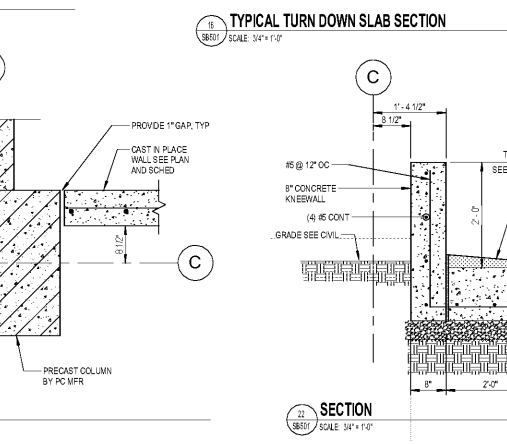
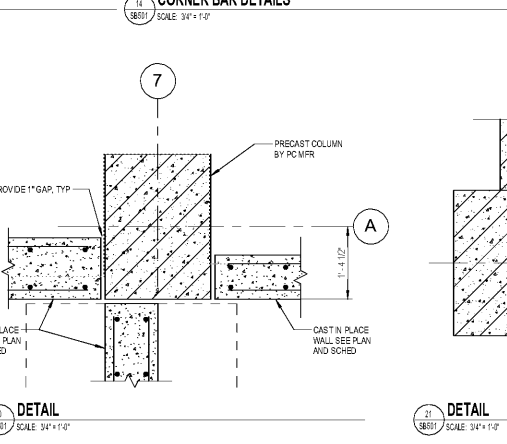
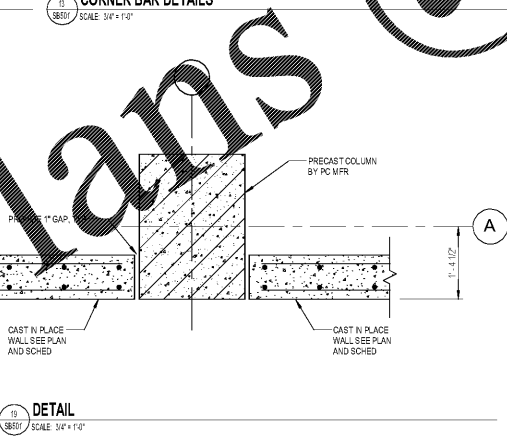
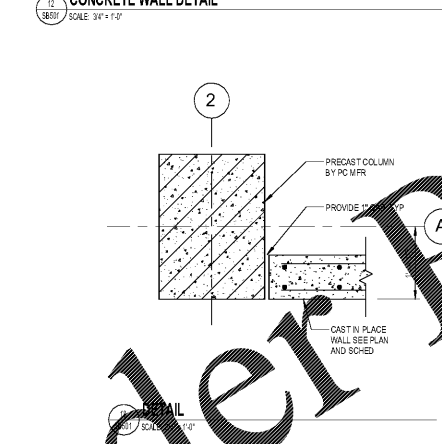
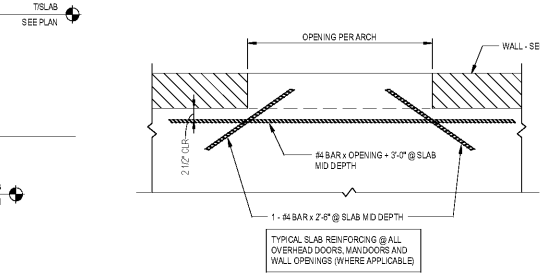
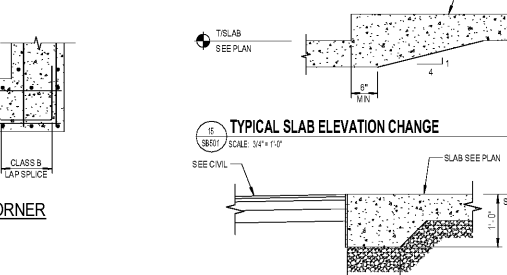
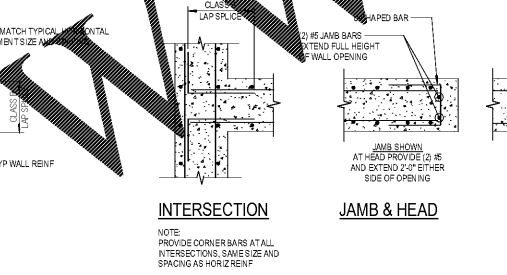
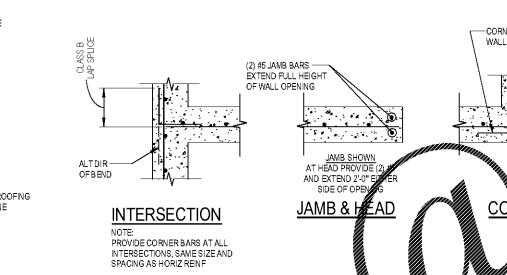
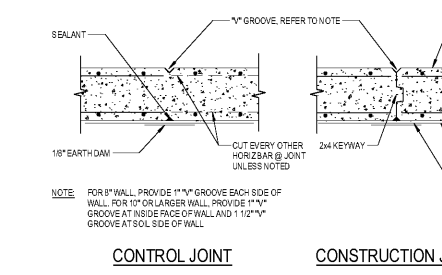
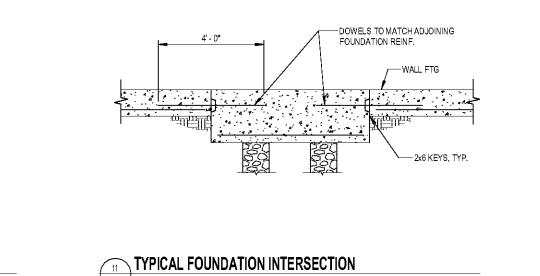
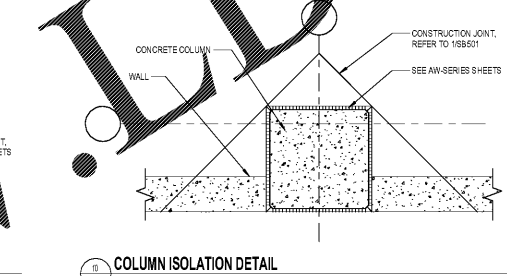
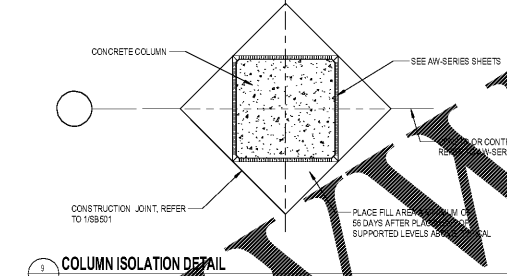
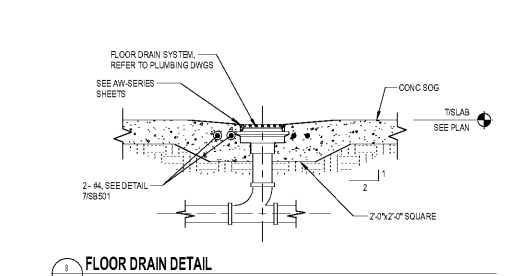
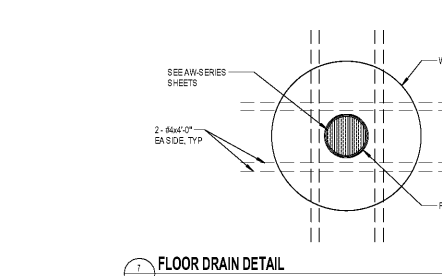
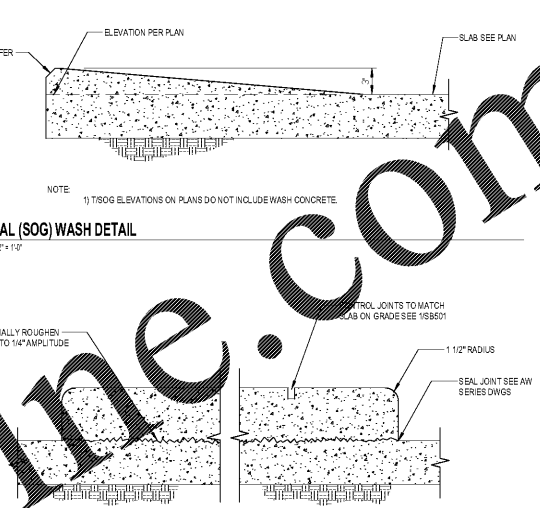
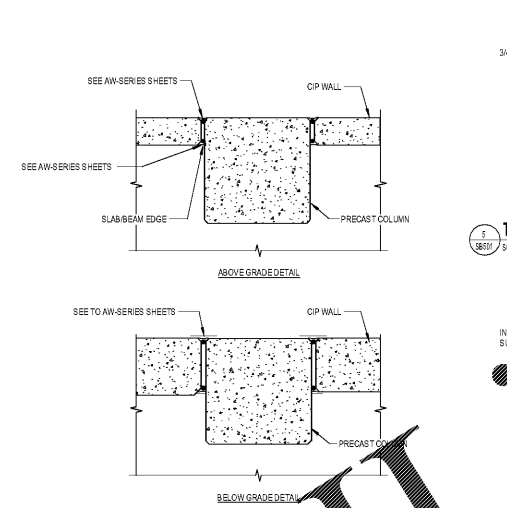
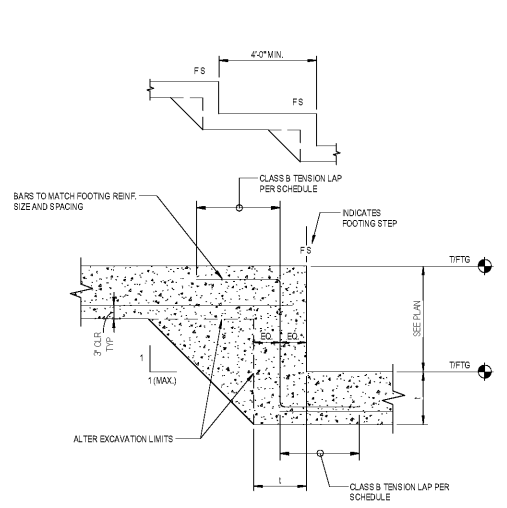
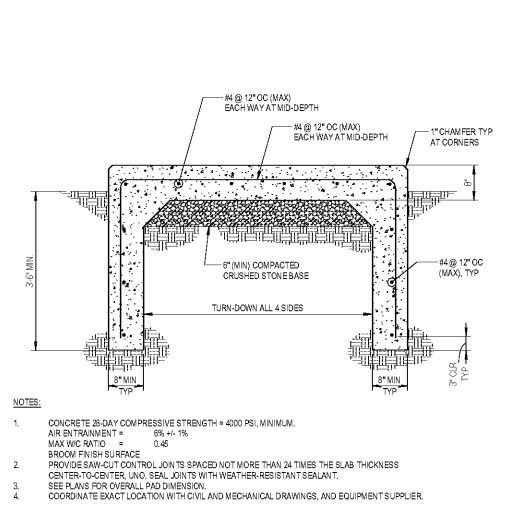
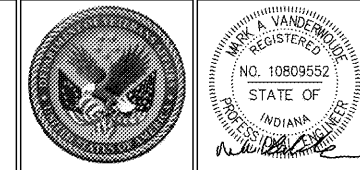

ARCHITECT/ENGINEERS:  
PROJECT LEAD Architect, Structural Engineer, Civil Engineer  
**GUIDON DESIGN**  
SUSTAINABLE ARCHITECTURE + ENGINEERING  
MEP Engineer APOGEE CONSULTING GROUP  
Functional Design CARL WALKER INC.1151 Kildaire Farm Rd., Suite 120, Cary, NC 27511  
3211 Internet Blvd., Suite 220, Frisco, TX 75034  
Tel: 919-858-7420 | Tel: 469-777-5143

BID SET			
Drawing Title TYPICAL FOUNDATION SECTIONS AND DETAILS	Project Title CONSTRUCT PARKING GARAGE ON WEST LOT	Project Number 15.1067	OFFICE OF FACILITIES MANAGEMENT
Approved for Design Concept: FACILITY MANAGEMENT DIVISION MANAGER	Location MEMPHIS, TN	Building Number	VA Project Number 614-319
Date 11/14/2016	Checked By: MAV	Drawn By: WJT	Drawing Number <b>SB501</b>