

16 LIQUOR STORAGE SECTION
1/2" = 1'-0"

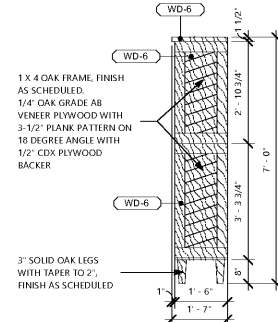

15 LIQUOR STORAGE SIDE ELEVATION
1/2" = 1'-0"

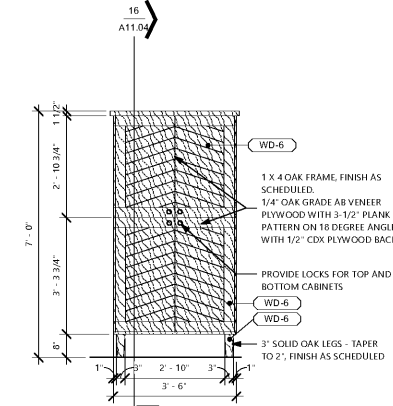

14 LIQUOR STORAGE FRONT ELEVATION
1/2" = 1'-0"

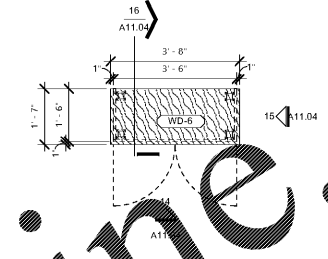

13 ENLARGED PLAN - LIQUOR STORAGE CABINET
1/2" = 1'-0"

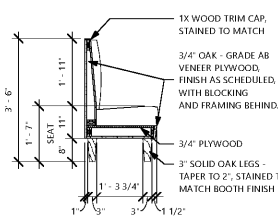
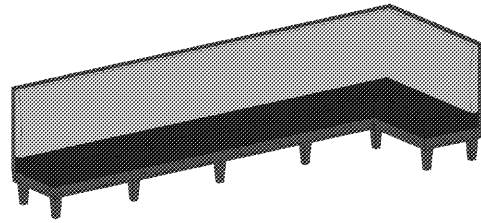

12 L - BANQUETTE SECTION
1/2" = 1'-0"

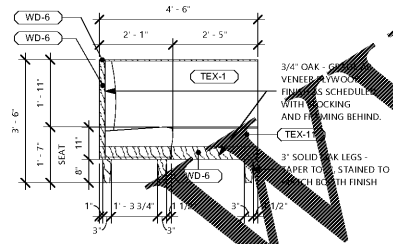

11 L - BANQUETTE SIDE ELEVATION
1/2" = 1'-0"

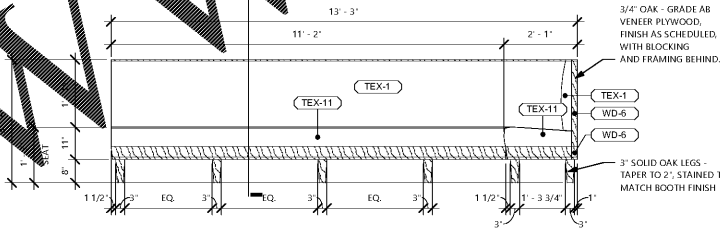

10 - BANQUETTE - FRONT ELEVATION
1/2" = 1'-0"

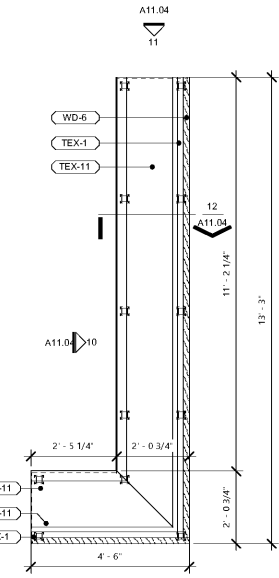

9 ENLARGED PLAN - TYP. L - BANQUETTE
1/2" = 1'-0"

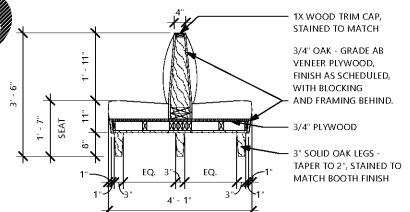

8 TYP. DOUBLE BOOTH SECTION 1
1/2" = 1'-0"

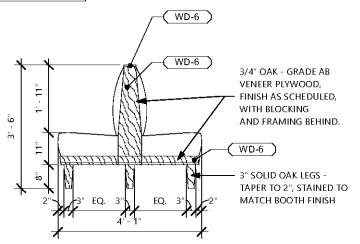

7 TYP. DOUBLE BOOTH ELEVATION B
1/2" = 1'-0"

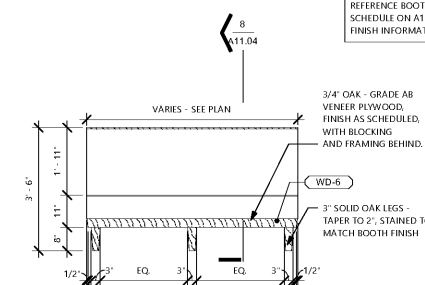

6 TYP. DOUBLE BOOTH ELEVATION A
1/2" = 1'-0"

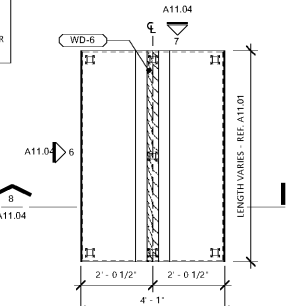

5 ENLARGED PLAN - TYP. DOUBLE BOOTH
1/2" = 1'-0"

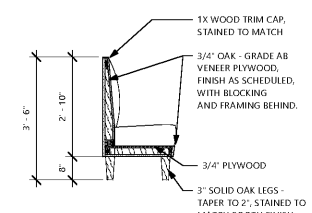

4 SINGLE BOOTH SECTION
1/2" = 1'-0"

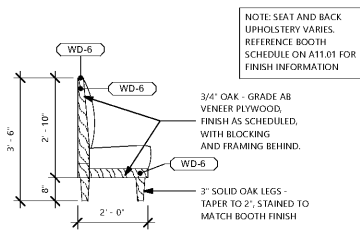

3 SINGLE BOOTH SIDE ELEVATION
1/2" = 1'-0"

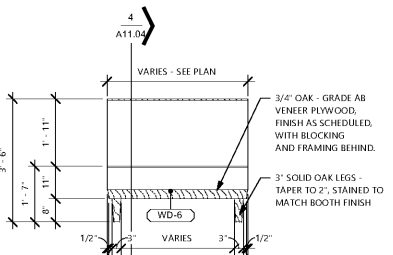

2 SINGLE BOOTH FRONT ELEVATION
1/2" = 1'-0"

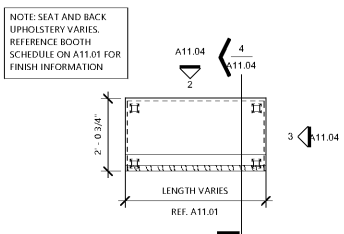

1 ENLARGED PLAN - TYP. SINGLE BOOTH
1/2" = 1'-0"

Order Plans @