

HOOD INFORMATION - Job#2887537				EXHAUST FAN				HOOD				
HOOD NO.	TAG	MODEL	LENGTH	MAX. COOKING TEMP.	TOTAL EXH. CFM	WIDTH	LENG.	DIA.	CFM	S.P.	CONSTRUCTION	HOOD HANGING WEIGHT
1	Back House Oven	6624	VHB	4' 6.00"	700	Dep.	450	12"	450	-0.041"	430 SS	227 LBS

CAPTIVE-AIRE HOODS ARE BUILT IN COMPLIANCE WITH

Inter-tek

NFPA #96
UL 710 & ULC710 STANDARDS
E.T.L. LISTED 3054804-001

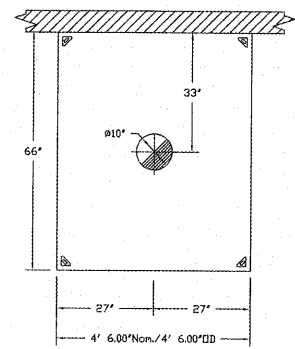

PLAN VIEW - Hood #1 (Back House Oven)
4' 6.00" LONG 6624VHB

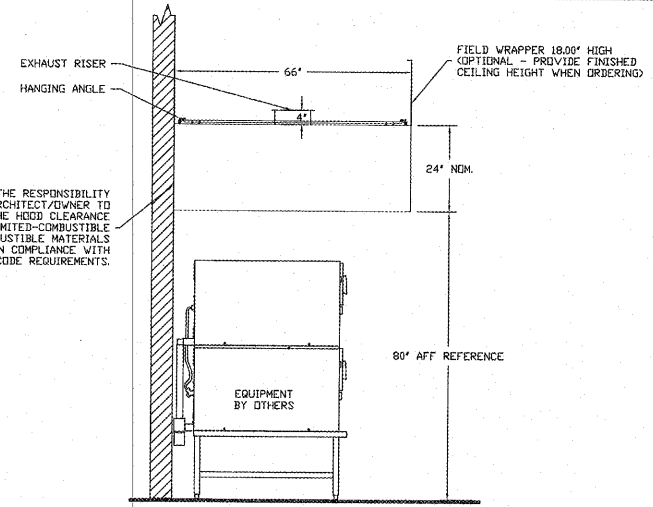

SECTION VIEW - MODEL 6624VHB
HOOD - #1 (Back House Oven)

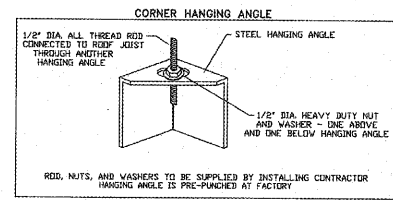

FOR QUESTIONS, CALL THE
SOUTHWEST FLORIDA REGIONAL OFFICE
4519 GEORGE RD, SUITE 150, TAMPA, FL 33634
PHONE: (800)378-2471 FAX: (813)354-4825

CAPTIVEAIRE

JOB Dunkin Donuts - Prototype 5.3
LOCATION, 0
DATE 1/13/2017 JOB # 2887537
DWC # 1 DRAWN BY DC
REV. SCALE 3/8" = 1'-0"

HOOD INFORMATION - Job#2887537				EXHAUST FAN				HOOD				
HOOD NO.	TAG	MODEL	LENGTH	MAX. COOKING TEMP.	TOTAL EXH. CFM	WIDTH	LENG.	DIA.	CFM	S.P.	CONSTRUCTION	HOOD HANGING WEIGHT
2	Sandwich Station	3624	VHB	700	Dep.	525	5' 3.00"	12"	525	-0.056"	430 SS	172 LBS

CAPTIVE-AIRE HOODS ARE BUILT IN COMPLIANCE WITH

Inter-tek

NFPA #96
UL 710 & ULC710 STANDARDS
E.T.L. LISTED 3054804-001

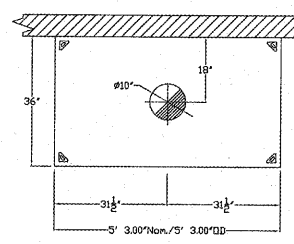

PLAN VIEW - Hood #2 (Sandwich Station)
5' 3.00" LONG 3624VHB

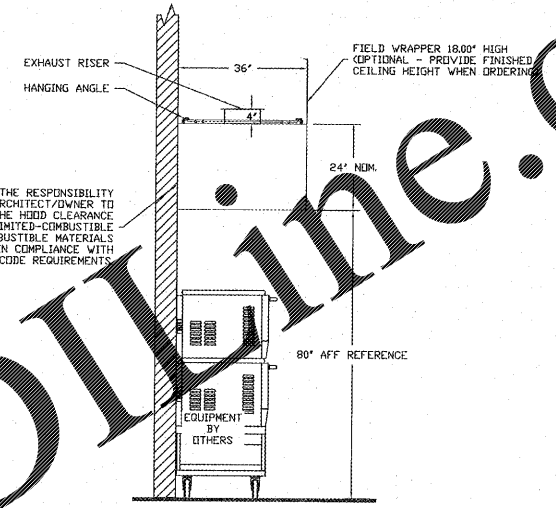

SECTION VIEW - MODEL 3624VHB
HOOD - #2 (Sandwich Station)

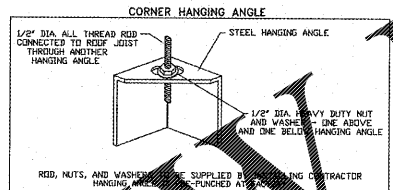

FOR QUESTIONS, CALL THE
SOUTHWEST FLORIDA REGIONAL OFFICE
4519 GEORGE RD, SUITE 150, TAMPA, FL 33634
PHONE: (800)378-2471 FAX: (813)354-4825

CAPTIVEAIRE

JOB Dunkin Donuts - Prototype 5.3
LOCATION, 0
DATE 1/13/2017 JOB # 2887537
DWC # 2 DRAWN BY DC
REV. SCALE 3/8" = 1'-0"

EXHAUST FAN INFORMATION - Job#2887537												
FAN UNIT NO.	TAG	FAN UNIT MODEL #	CFM	ESP.	RPM	HP.	B.H.P.	Ø	VOLT	FLA	WEIGHT (LBS.)	SDNES
1	Backhouse Oven	DJ33HFA	450	0.500	1300	0.250	0.1499	1	115	1.3	44	9.2

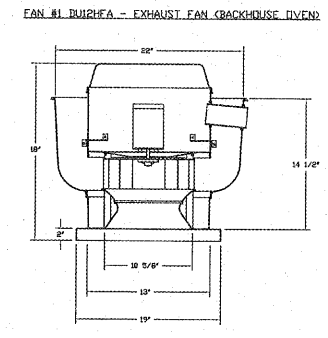

- FEATURES:**
- DIRECT DRIVE CONSTRUCTION (NO BELTS/PULLEYS)
 - ROOF MOUNTED FAN
 - UL710
 - VARIABLE SPEED CONTROL
 - INTERNAL WIRING
 - WEATHERPROOF RECONNECT
 - THERMAL OVERLOAD PROTECTION (SINGLE PHASE)
- OPTIONS:**
- SCR-12 BIRD SCREEN
 - ECM WIRING PACKAGE
 - I 15-BDD DAMPER

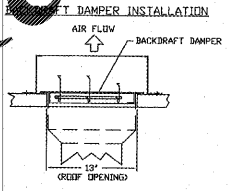
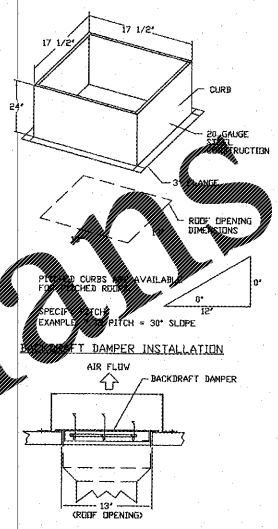

FOR QUESTIONS, CALL THE
SOUTHWEST FLORIDA REGIONAL OFFICE
4519 GEORGE RD, SUITE 150, TAMPA, FL 33634
PHONE: (800)378-2471 FAX: (813)354-4825

CAPTIVEAIRE

JOB Dunkin Donuts - Prototype 5.3
LOCATION, 0
DATE 1/13/2017 JOB # 2887537
DWC # 3 DRAWN BY DC
REV. SCALE 3/8" = 1'-0"

EXHAUST FAN INFORMATION - Job#2887537												
FAN UNIT NO.	TAG	FAN UNIT MODEL #	CFM	ESP.	RPM	HP.	B.H.P.	Ø	VOLT	FLA	WEIGHT (LBS.)	SDNES
2	Sandwich Station	DJ33HFA	525	0.500	1212	0.333	0.1210	1	115	4.4	58	7.7

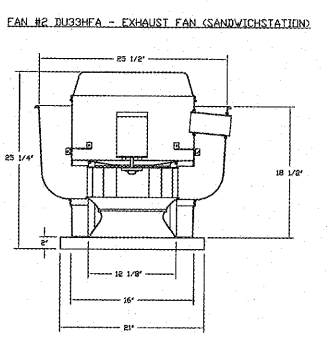

- FEATURES:**
- DIRECT DRIVE CONSTRUCTION (NO BELTS/PULLEYS)
 - ROOF MOUNTED FAN
 - UL710
 - VARIABLE SPEED CONTROL
 - INTERNAL WIRING
 - WEATHERPROOF RECONNECT
 - THERMAL OVERLOAD PROTECTION (SINGLE PHASE)
- OPTIONS:**
- ECM WIRING PACKAGE
 - SCR-11 BIRD SCREEN
 - I 15-BDD DAMPER

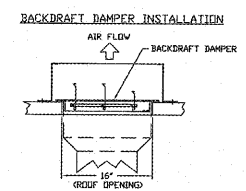
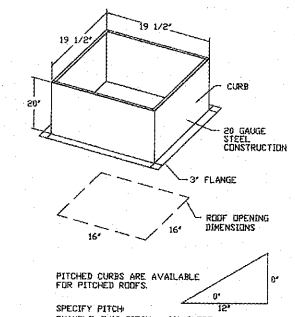

FOR QUESTIONS, CALL THE
SOUTHWEST FLORIDA REGIONAL OFFICE
4519 GEORGE RD, SUITE 150, TAMPA, FL 33634
PHONE: (800)378-2471 FAX: (813)354-4825

CAPTIVEAIRE

JOB Dunkin Donuts - Prototype 5.3
LOCATION, 0
DATE 1/13/2017 JOB # 2887537
DWC # 4 DRAWN BY DC
REV. SCALE 3/8" = 1'-0"

Order Plans @

WWW.LDOnline.com

THESE PLANS ARE CONFIDENTIAL PROPERTY OF DUNKIN' BRANDS, INC. UNLESS OTHERWISE RESTRICTED ACCESS.

dunkin' brands

PROJECT NO: 17229

NRD national restaurant designers
ARCHITECTS & ENGINEERS

3005 Carrington Mill Blvd., Morrisville, NC 27560
ph: 919 544 7291 fax: 919 544 9399
A Division of LMNT Associates

NO	DESCRIPTION	DATE	SCALE	DRAWN	CKD	APPD

DD FRESH BREW 1.0
DUNKIN DESIGN GUIDELINES
CAPTIVE AIR HOOD DATA
HOOD, FAN, AND CONTROLS

PC NUMBER
M-4.0