

#ATL034
CONYERS, GA

Krystal



3/22/18

ISSUED FOR CONSTRUCTION
 1447 Highway 138
 Conyers, Georgia 30012
 Rockdale County, Georgia

Revisions		
#	Date	Description

Project Number: 19028
 Issued for: CONSTRUCTION
 Issue Date: 03/22/18

DRAWING TITLE
MECHANICAL DETAILS

SHEET NUMBER
M200

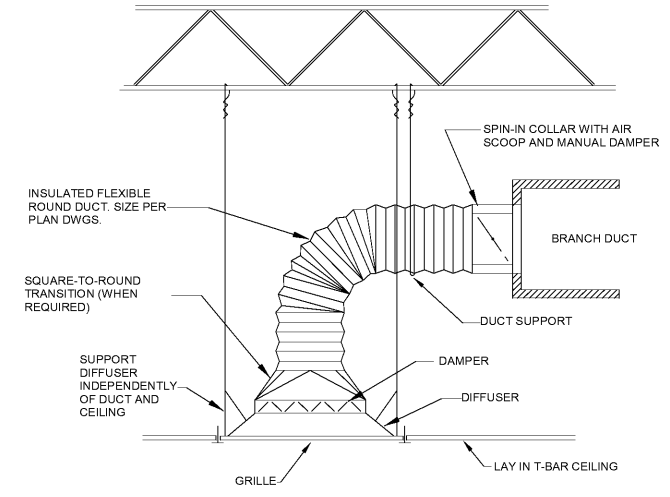

1 LAY-IN AIR DEVICE INSTALLATION DETAIL
 NOT TO SCALE

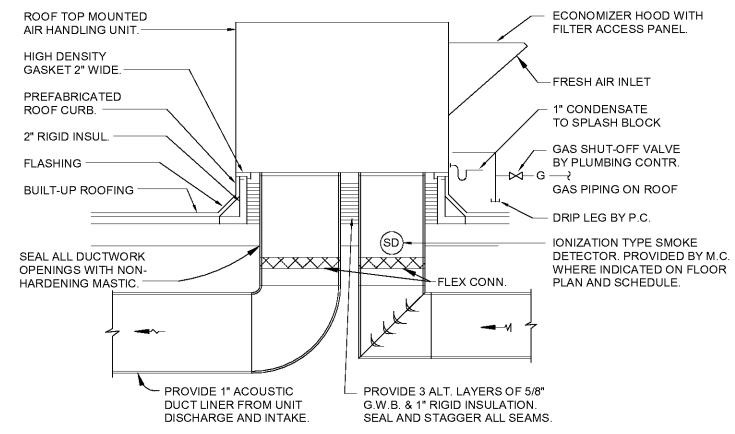

2 ROOFTOP UNIT WITH GAS HEAT
 NOT TO SCALE

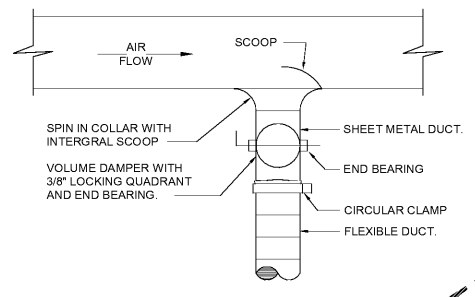

3 BRANCH TAKEOFF TO SINGLE OUTLET
 NOT TO SCALE

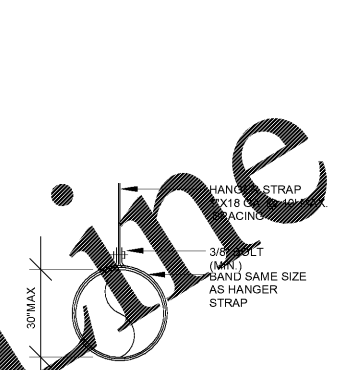

4 ROUND DUCT HANGER DETAIL
 NOT TO SCALE

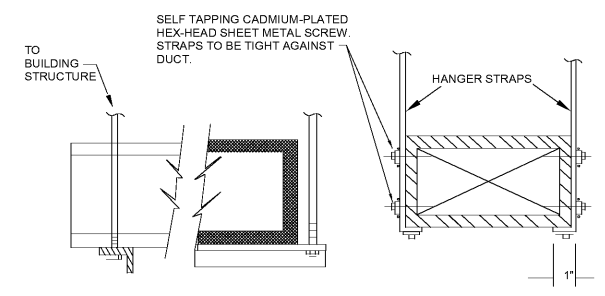

5 RECTANGULAR DUCT HANGER DETAIL
 NOT TO SCALE

HANGER SIZES FOR RECTANGULAR DUCTS			
MAX. SIDE	HANGER	SUPPORT ANGLE HORIZONTAL	SPACING MAXIMUM
30"	1" x 1/8" GAUGE STRAP	NONE REQUIRED	10'-0"
36"	1/4" ROUND ROD	1-1/2" x 1-1/2" x 1/8"	8'-0"
48"	1/4" ROUND ROD	2" x 2" x 1/8"	8'-0"
60"	5/16" ROUND ROD	2" x 2" x 1/8"	8'-0"
84"	3/8" ROUND ROD	2" x 2" x 1/8"	8'-0"

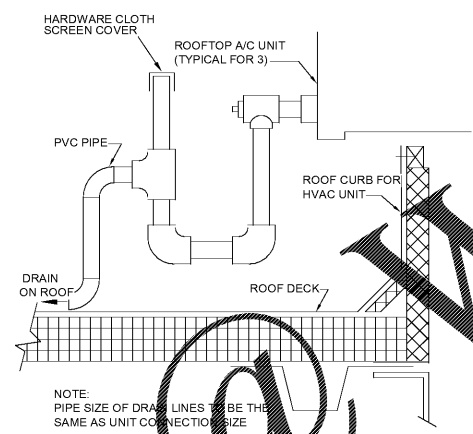

6 \"/>

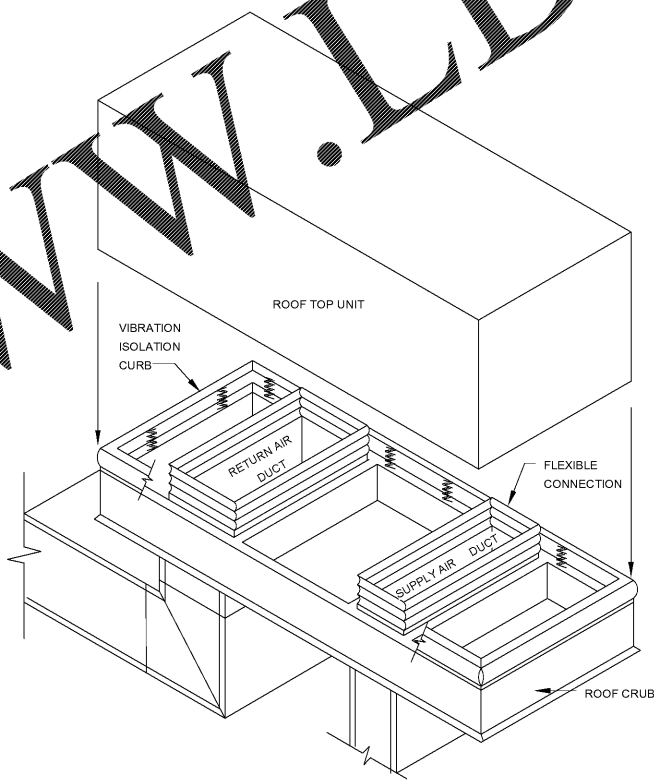

7 ROOFTOP UNIT CURB DETAIL
 NOT TO SCALE

Order Plans