

1 SECTION
S4.01 NTS

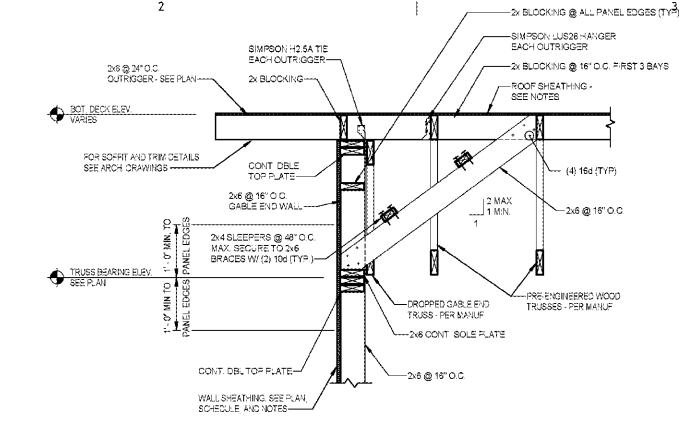

2 SECTION
S4.01 3/4" = 1'-0"

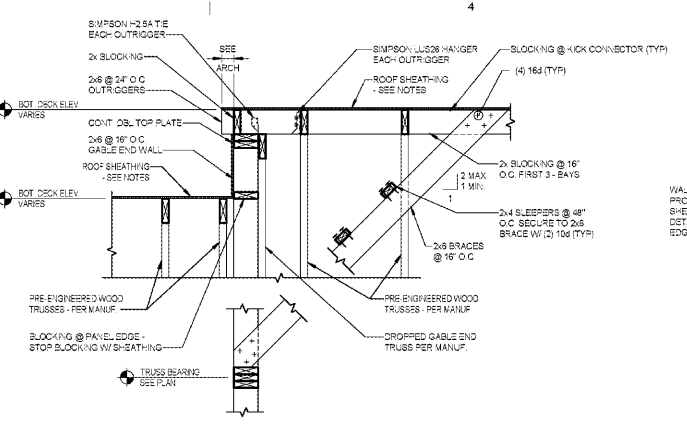

3 SECTION
S4.01 NTS

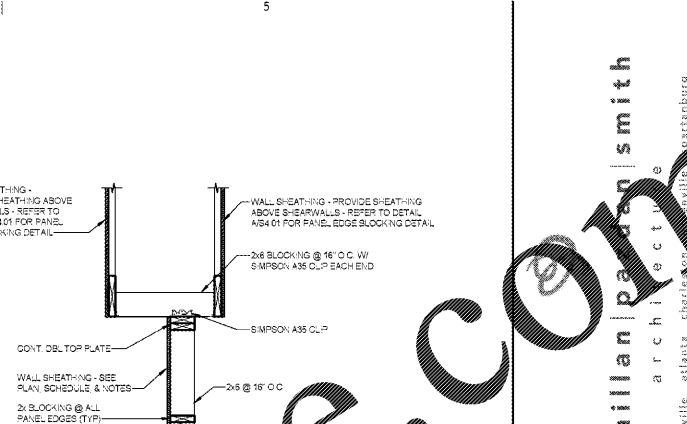

4 SECTION
S4.01 NTS

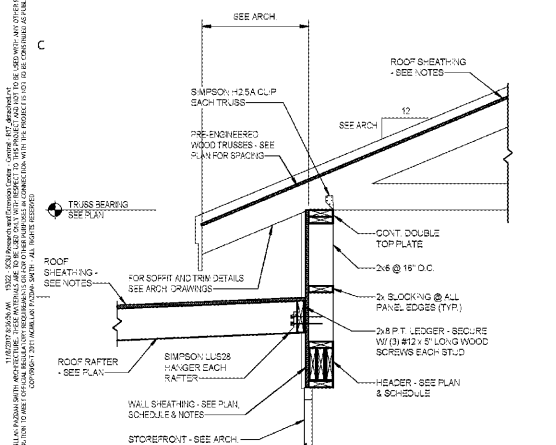

5 SECTION
S4.01 NTS

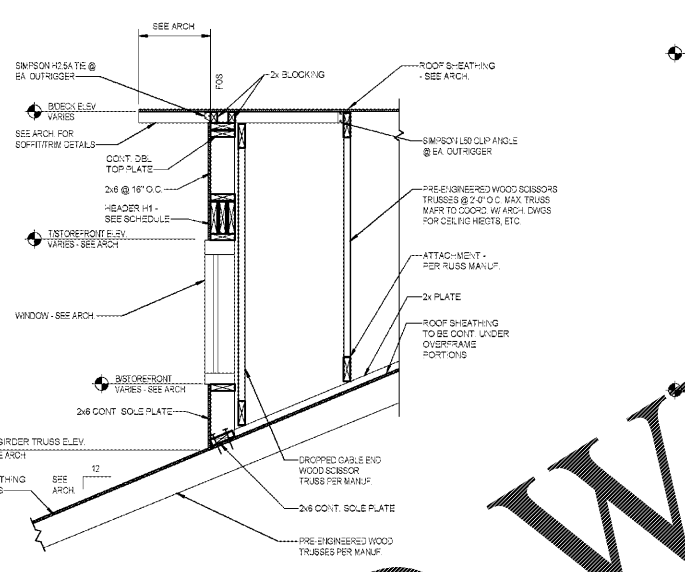

6 SECTION
S4.01 NTS

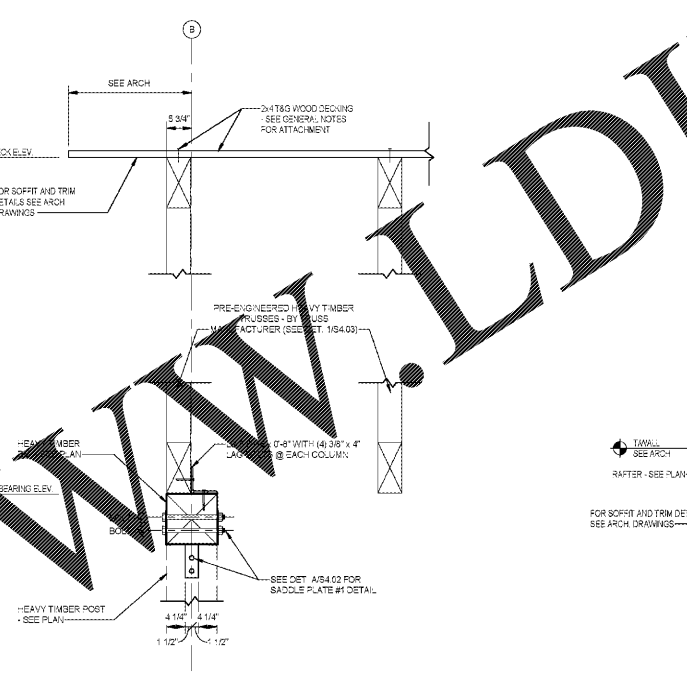

7 SECTION
S4.01 3/4" = 1'-0"

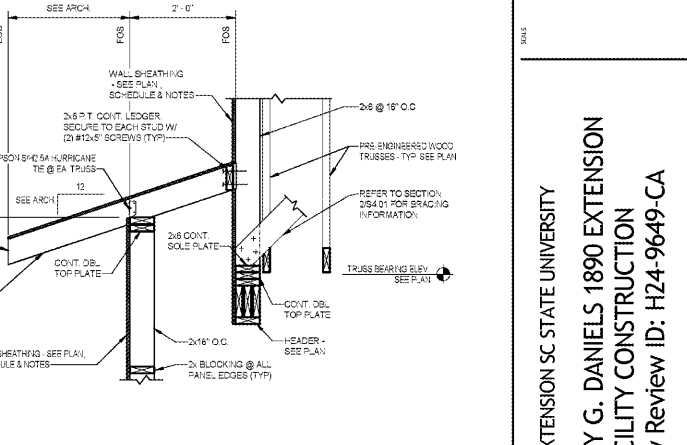

8 SECTION
S4.01 NTS

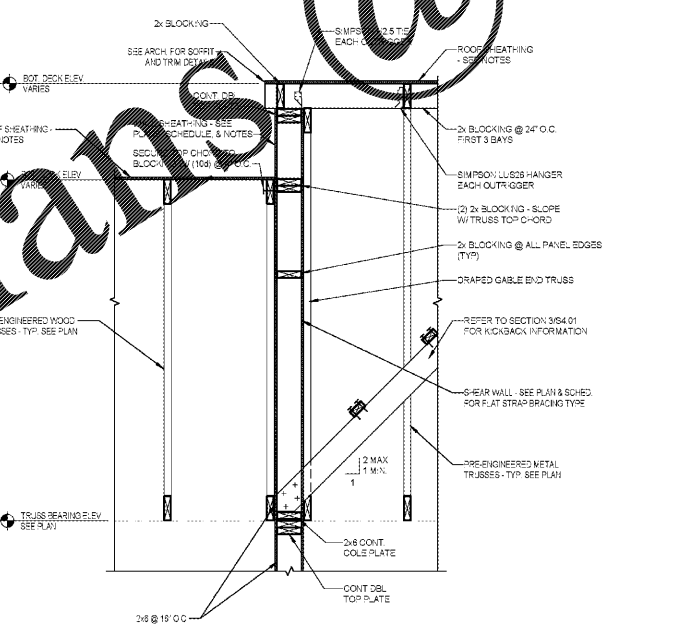

9 SECTION
S4.01 3/4" = 1'-0"

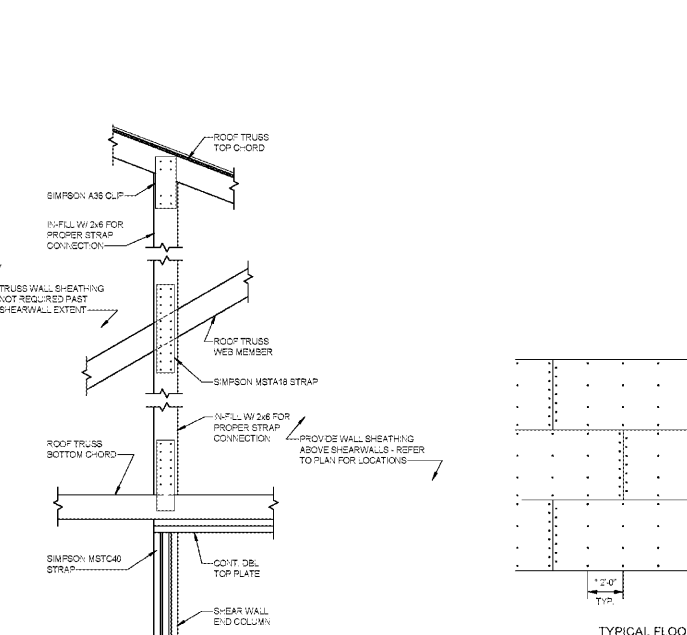

10 SECTION
S4.01 NTS

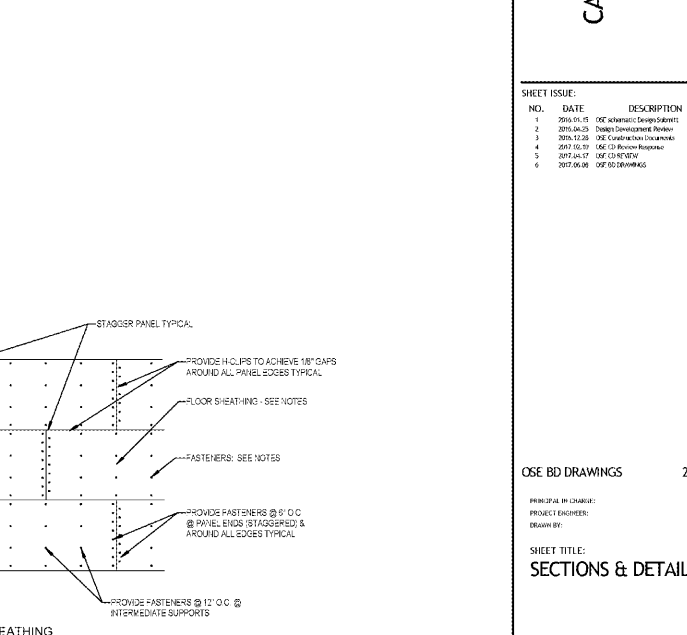

DETAIL B
S4.01 NTS

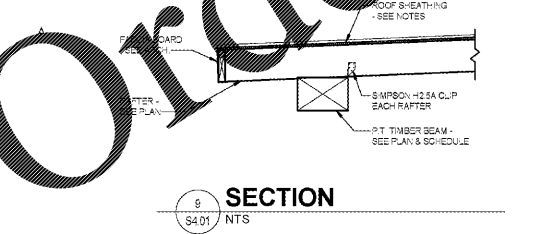

11 SECTION
S4.01 NTS

WWW.LDILINE.COM

ALL DRAWINGS, SPECIFICATIONS AND NOTES SUBJECT TO CHANGE WITHOUT NOTICE. THE USER OF ANY DRAWING OR SPECIFICATION HEREBY AGREES TO HOLD THE DESIGNER HARMLESS FROM AND AGAINST ALL LIABILITY, INCLUDING REASONABLE ATTORNEY'S FEES, FOR ANY AND ALL DAMAGES, LOSSES AND EXPENSES, INCLUDING REASONABLE ATTORNEY'S FEES, INCURRED BY THE USER OF ANY DRAWING OR SPECIFICATION HEREBY AS A RESULT OF THE USER'S USE OF ANY DRAWING OR SPECIFICATION HEREBY. THE USER OF ANY DRAWING OR SPECIFICATION HEREBY AGREES TO HOLD THE DESIGNER HARMLESS FROM AND AGAINST ALL LIABILITY, INCLUDING REASONABLE ATTORNEY'S FEES, FOR ANY AND ALL DAMAGES, LOSSES AND EXPENSES, INCLUDING REASONABLE ATTORNEY'S FEES, INCURRED BY THE USER OF ANY DRAWING OR SPECIFICATION HEREBY AS A RESULT OF THE USER'S USE OF ANY DRAWING OR SPECIFICATION HEREBY.

FULLER mc millan | parrin | smith
 STRUCTURAL ARCHITECTURE
 1500 C. DOWNS RD.
 SUITE 200
 ASHEVILLE, NC 28701
 PHONE: 828.252.2034
 FAX: 828.252.2034
 WWW.FULLERMCMILLAN.COM

1890 EXTENSION SC STATE UNIVERSITY
CAMP HARRY G. DANIELS 1890 EXTENSION
FACILITY CONSTRUCTION
 Agency Review ID: H24-9649-CA
 116 Camp Daniels Road, Ellenton, SC

SHEET ISSUE:

| NO. | DATE | DESCRIPTION | BY |
|-----|------------|------------------------------|-----|
| 1 | 2016.04.15 | 02E - Structural Development | WTF |
| 2 | 2016.04.20 | 02E - Development Review | WTF |
| 3 | 2016.05.26 | 02E - Construction Documents | WTF |
| 4 | 2017.01.17 | 02E - Construction Documents | WTF |
| 5 | 2017.04.17 | 02E - Construction Documents | WTF |
| 6 | 2017.06.08 | 02E - Construction Documents | WTF |

OSE BD DRAWINGS 2017.06.08
 PROJECT ENGINEER: WTT
 DRAWN BY: JMM
 SHEET TITLE: SECTIONS & DETAILS

SHEET NO. S4.01
 PROJ. NO. 13140.00