



Chick-fil-A
 5200 Buffington Road
 Atlanta, Georgia 30349-2998

INTERPLAN
 ARCHITECTURE
 ENGINEERING
 INTERIOR DESIGN
 PROJECT MANAGEMENT

604 COURTLAND STREET
 SUITE 100
 ORLANDO, FLORIDA 32804
 PH 407.645.5008
 FX 407.629.9124

SEAL: THIS DOCUMENT IS NOT FOR CONSTRUCTION UNLESS THE ARCHITECT'S OR ENGINEER'S SIGNATURE AND SEAL APPEAR BELOW.

CHICK-FIL-A
SAR South Cobb Drive FSR
 3100 South Cobb DR SE, Smyrna, GA 30080

FSR# 00810

REVISION	SCHEDULE	DESCRIPTION
NO.	DATE	

CONSULTANT PROJECT #	2017.0165
PRINTED FOR	BID
DATE	September 09, 2017
DRAWN BY	AD

Information contained on this drawing and in all digital files produced for this project shall be the property of INTERPLAN and shall not be reproduced, stored in a retrieval system, or transmitted in any form or by any means, electronic, mechanical, photocopying, recording, or by any information storage and retrieval system, without the prior written permission of INTERPLAN.

SHEET INTERIOR DETAILS

SHEET NUMBER **A-620**

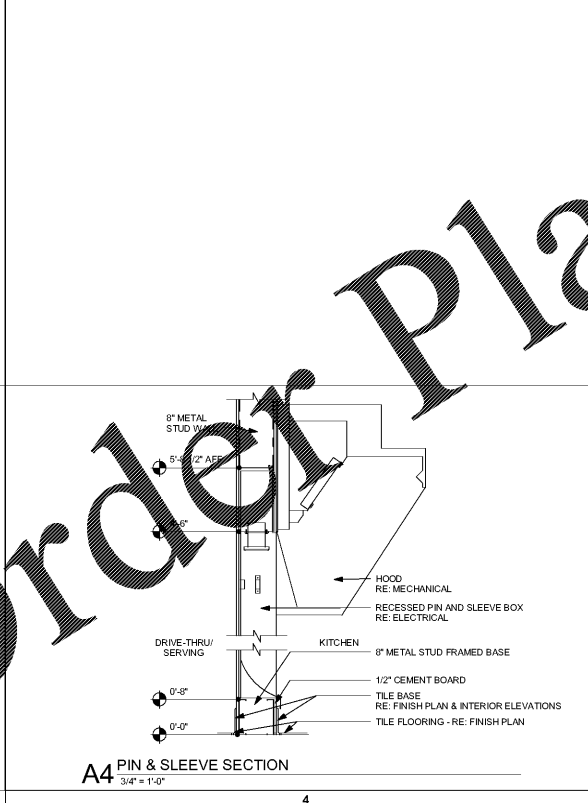
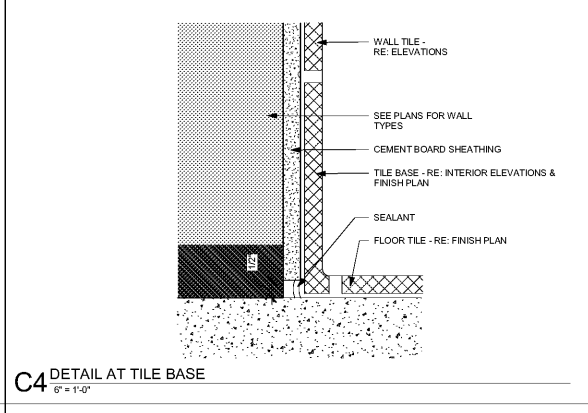
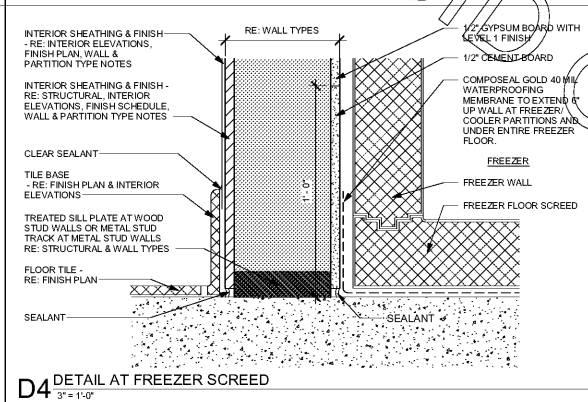
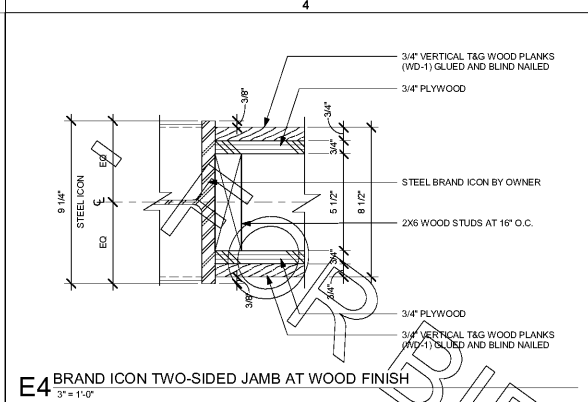
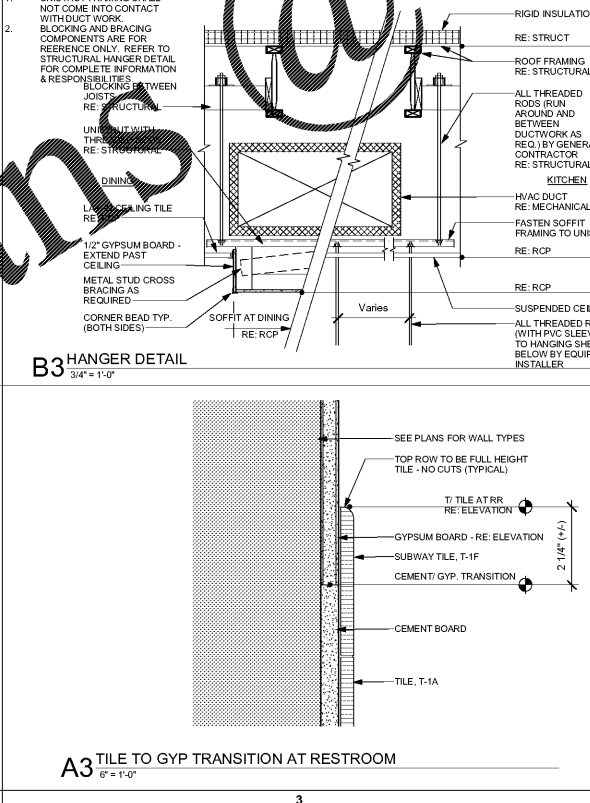
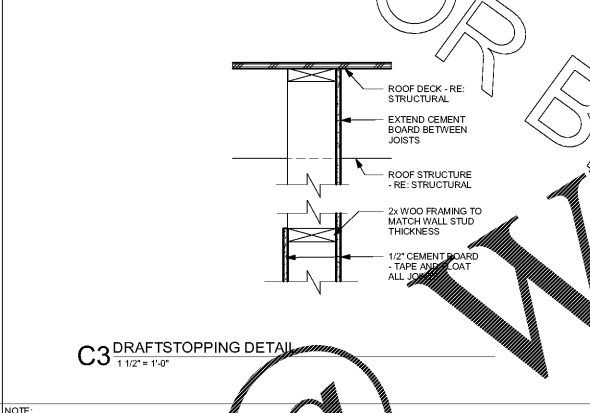
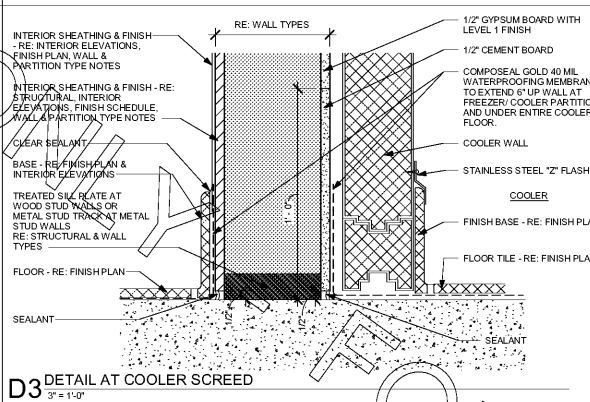
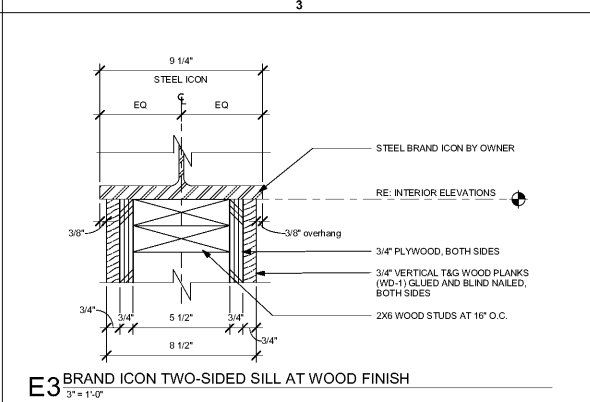
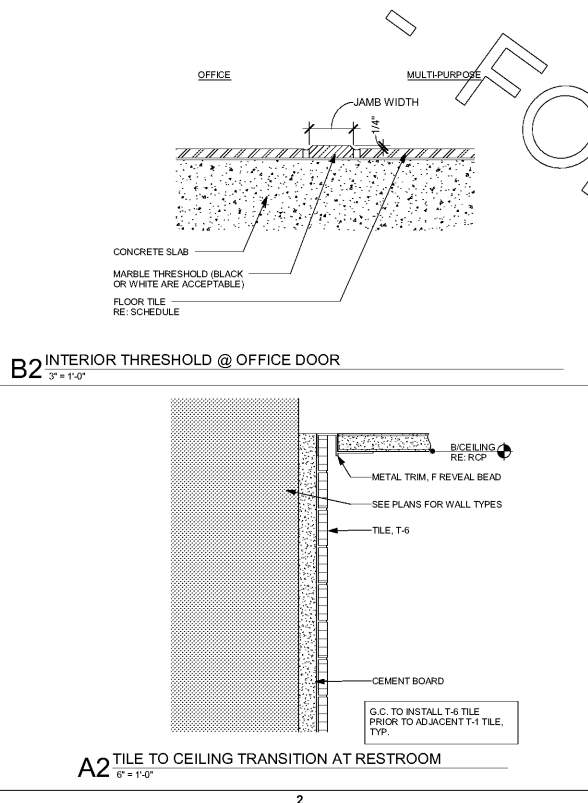
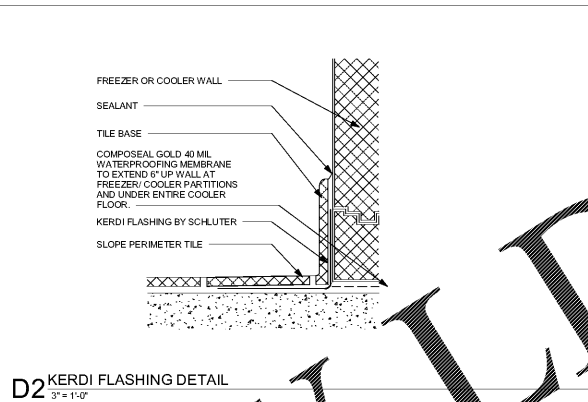
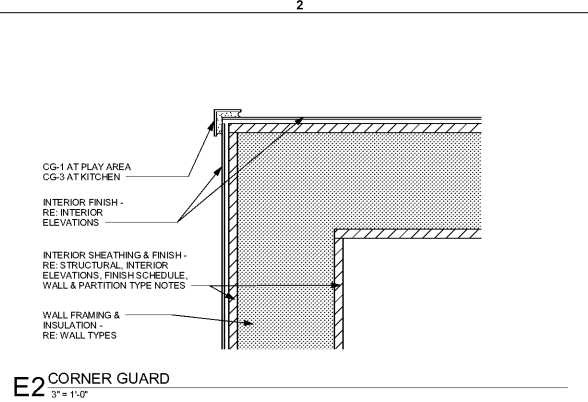
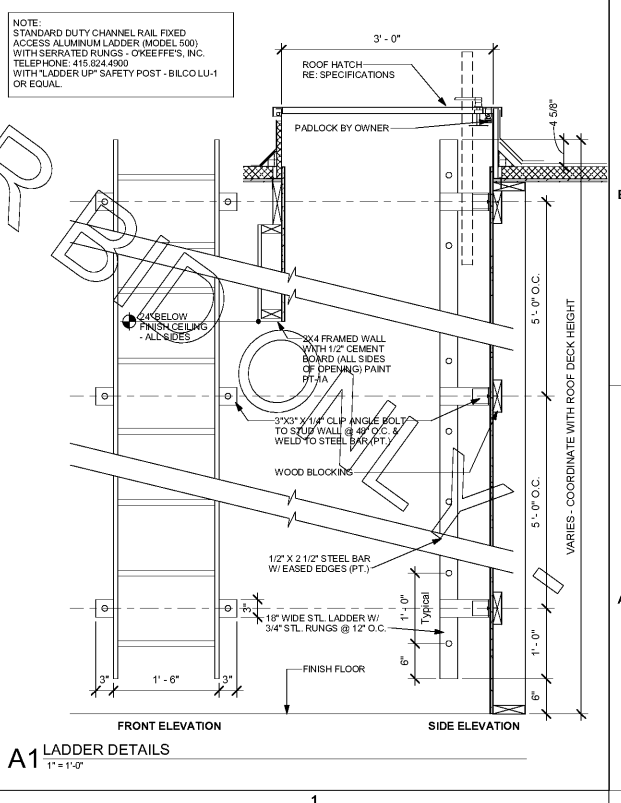
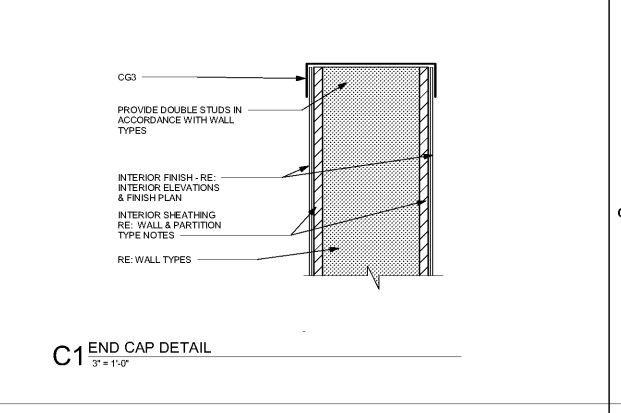
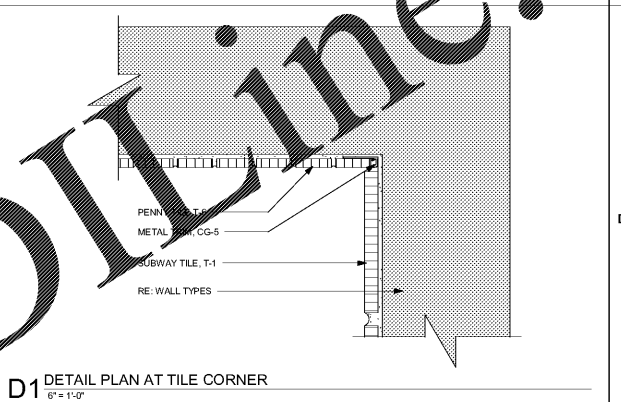
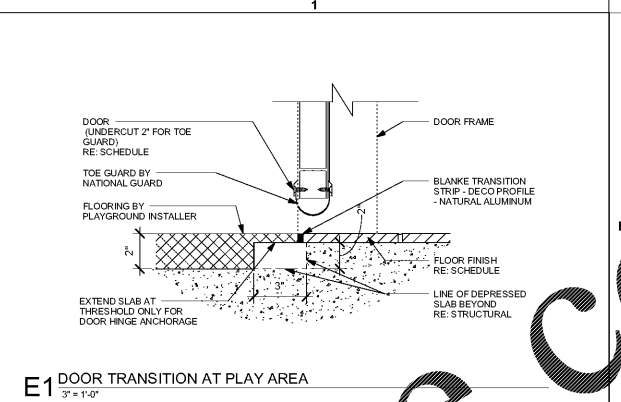

2/5/2018 10:03:48 PM

Order Plans @ WWW.LDLINE.COM

FOR BIDDING ONLY