

FOR BID ONLY



D-Series Size 0 LED Area Luminaire

Specifications table for D-Series luminaire including length, width, height, weight, and part numbers (e.g., 40C, 40B, 40M).

Introduction

The modern styling of the D-Series is striking yet unobtrusive - making a bold, progressive statement even as it blends seamlessly with its environment.

The D-Series distills the benefits of the latest in LED technology into a high performance, high efficacy, long life luminaire. The outstanding photometric performance results in sites with excellent uniformity, greater pole-spacing and lower power density. It is ideal for replacing up to 400W metal halide with typical energy savings of 65% and expected service life of over 100,000 hours.

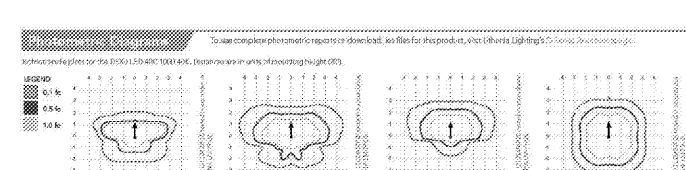
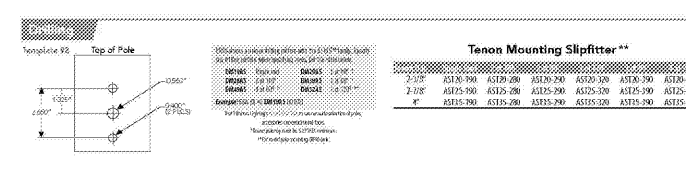

Lumen Ambient Temperature (LAT) Multipliers table showing values for different ambient temperatures (95°F to 40°F).

Electrical Load table showing values for different luminaire models and wattages.

Lumen Output

Lumen output is based on the luminaire's beam pattern, 1.5m wide with 2.0m, 3.0m, 4.0m, 5.0m, 6.0m, 7.0m, 8.0m, 9.0m, 10.0m, 11.0m, 12.0m, 13.0m, 14.0m, 15.0m, 16.0m, 17.0m, 18.0m, 19.0m, 20.0m, 21.0m, 22.0m, 23.0m, 24.0m, 25.0m, 26.0m, 27.0m, 28.0m, 29.0m, 30.0m, 31.0m, 32.0m, 33.0m, 34.0m, 35.0m, 36.0m, 37.0m, 38.0m, 39.0m, 40.0m, 41.0m, 42.0m, 43.0m, 44.0m, 45.0m, 46.0m, 47.0m, 48.0m, 49.0m, 50.0m, 51.0m, 52.0m, 53.0m, 54.0m, 55.0m, 56.0m, 57.0m, 58.0m, 59.0m, 60.0m, 61.0m, 62.0m, 63.0m, 64.0m, 65.0m, 66.0m, 67.0m, 68.0m, 69.0m, 70.0m, 71.0m, 72.0m, 73.0m, 74.0m, 75.0m, 76.0m, 77.0m, 78.0m, 79.0m, 80.0m, 81.0m, 82.0m, 83.0m, 84.0m, 85.0m, 86.0m, 87.0m, 88.0m, 89.0m, 90.0m, 91.0m, 92.0m, 93.0m, 94.0m, 95.0m, 96.0m, 97.0m, 98.0m, 99.0m, 100.0m.

Main Lumen Output table with columns for luminaire model, wattage, beam diameter, and lumen output.

LITHONIA LIGHTING One Lithonia Way • Conover, Georgia 30024 • Phone 800.279.8941 • Fax 770.938.1500 • www.lithonia.com

One Lithonia Way • Conover, Georgia 30024 • Phone 800.279.8941 • Fax 770.938.1500 • www.lithonia.com

One Lithonia Way • Conover, Georgia 30024 • Phone 800.279.8941 • Fax 770.938.1500 • www.lithonia.com

One Lithonia Way • Conover, Georgia 30024 • Phone 800.279.8941 • Fax 770.938.1500 • www.lithonia.com

One Lithonia Way • Conover, Georgia 30024 • Phone 800.279.8941 • Fax 770.938.1500 • www.lithonia.com

One Lithonia Way • Conover, Georgia 30024 • Phone 800.279.8941 • Fax 770.938.1500 • www.lithonia.com



SSS SQUARE STRAIGHT STEEL

FEATURES & SPECIFICATIONS

CONSTRUCTION - Weldable-grade, hot-dipped, commercial-quality carbon steel tubing with a minimum yield of 55,000 psi (11-gauge), 55,000 psi (7-gauge) for 10 and 12-gauge tubing. 10-gauge tubing is a minimum with a full-length longitudinal, high-frequency electric resistance weld. Uniformly square in cross-section with flat sides, small corner radii and excellent torsional qualities. Available in 12-gauge or 10-gauge tubing with a full-length longitudinal, high-frequency electric resistance weld.

ORDERING INFORMATION

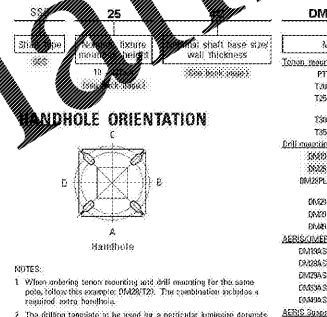

- NOTES:** 1. When ordering tenon mounting and drill mounting for the same pole, indicate this option: DM19-DDB. 2. The quantity required is to be used for a particular luminaire section at the luminaire. Refer to the Technical Data Section of the luminaire manual for mounting information. 3. Mount 7" x 7" to 24" x 24" to dimensions shown on the drawing. 4. Specify location and orientation when ordering options. 5. For 14" x 14" specify the height in feet above base of pole. 6. Horizontal mounting is 18" x 24" or 18" x 18" unless specified. 7. Additional colors available; see www.lithonia.com or Lithonia Sales brochure (Form PL-745) Powder Coat, standard.

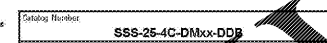

SSS SQUARE STRAIGHT STEEL

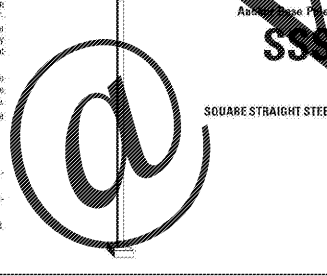

ORDERING INFORMATION

Ordering information table with columns for size (DM19, DM29, DDB), mounting, finish, and other specifications.



SSS SQUARE STRAIGHT STEEL POLES

Technical information table showing dimensions and weights for SSS Square Straight Steel Poles.

BASE DETAIL

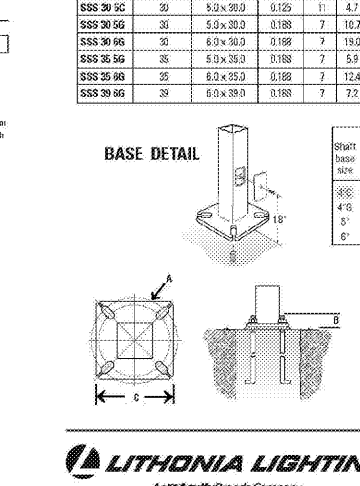

SSS SQUARE STRAIGHT STEEL POLES

Technical information table showing dimensions and weights for SSS Square Straight Steel Poles.

BASE DETAIL

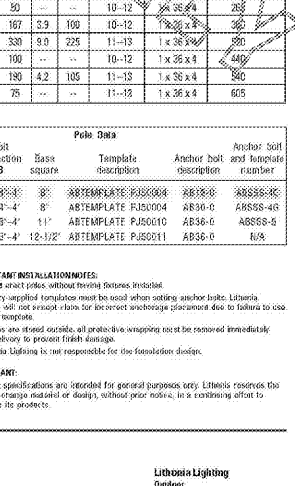

Chick-fil-A
5200 Buffington Road
Atlanta, Georgia 30349-2998



INTERPLANS
ARCHITECTURE
ENGINEERING
INTERIOR DESIGN
PROJECT MANAGEMENT

604 COURTLAND STREET
SUITE 100
ORLANDO, FLORIDA 32804
PH 407.645.5008
FX 407.629.9124

SEAL: THIS DOCUMENT IS NOT FOR CONSTRUCTION UNLESS THE ARCHITECT'S SIGNATURE AND SEAL APPEAR BELOW

STUART ANDERSON, P.E.
GA. REG.# PE038342

STUART ANDERSON, P.E.
GA. REG.# PE038342

CHICK-FIL-A
SAR South Cobb FSR
3100 SOUTH COBB DRIVE SE.
SMYRNA, GEORGIA 30080

FSR# 0810

REVISION SCHEDULE
NO. DATE DESCRIPTION

CONSULTANT PROJECT # 2017.0165

PRINTED FOR Permit

DATE 10/20/17

DRAWN BY MJ

CHECKED BY OEG

Information contained on this drawing and in all digital files produced for above named project may not be reproduced in any manner without express written or verbal consent from authorized project personnel.

SHEET SITE LIGHTING CUT SHEETS

SHEET NUMBER ES-2.0