

1 COBB COUNTY STANDARD SIDEWALK DETAIL

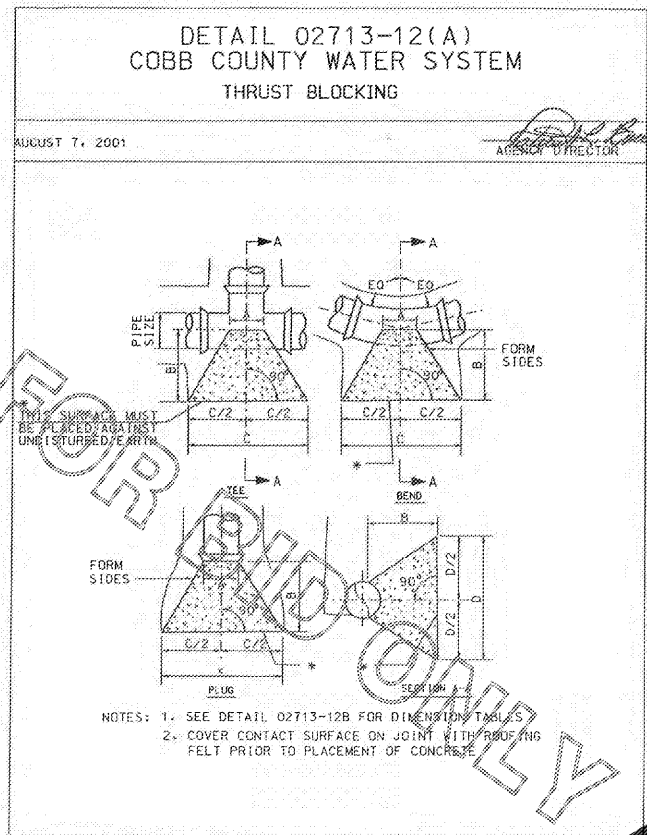

2 COBB COUNTY STANDARD THRUST BLOCKING DETAIL

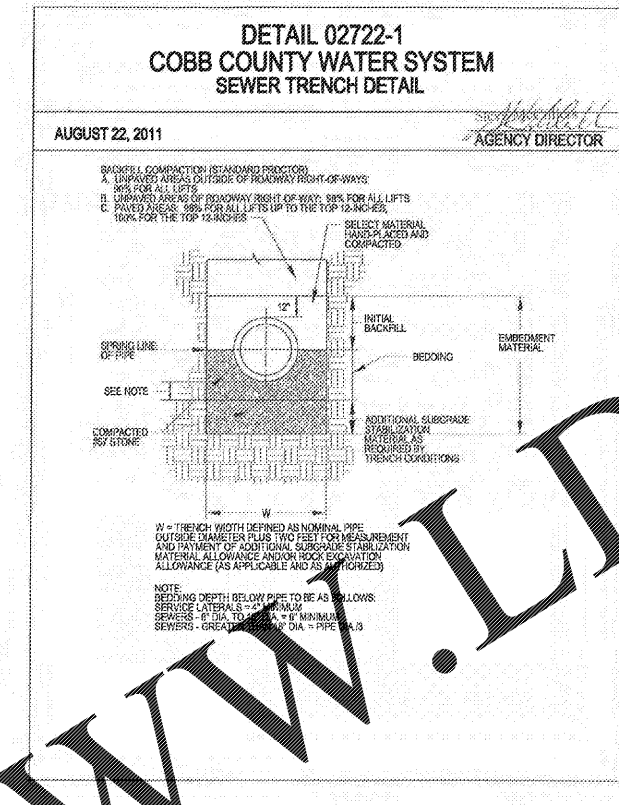

3 COBB COUNTY STANDARD SEWER TRENCH DETAIL

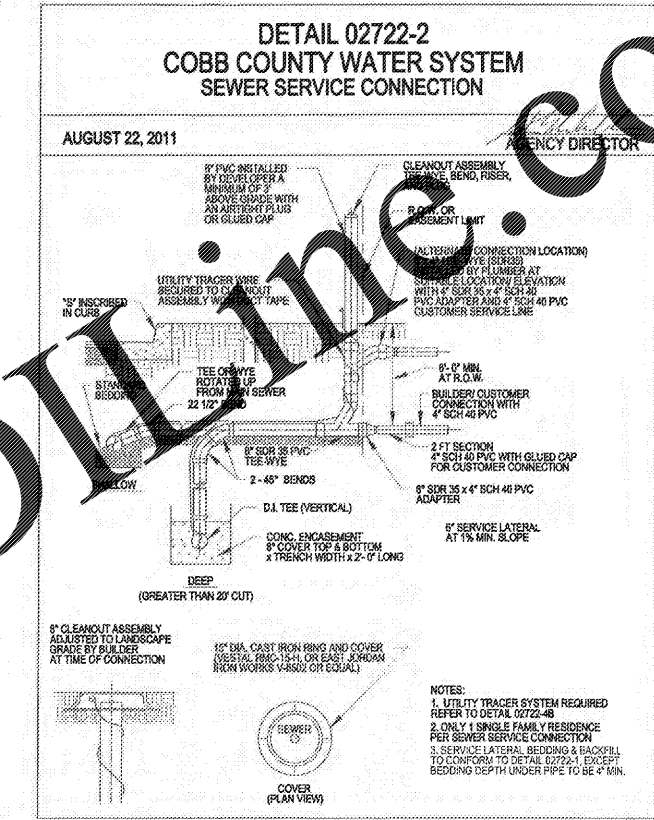

4 COBB COUNTY STANDARD SEWER SERVICE CONNECTION DETAIL

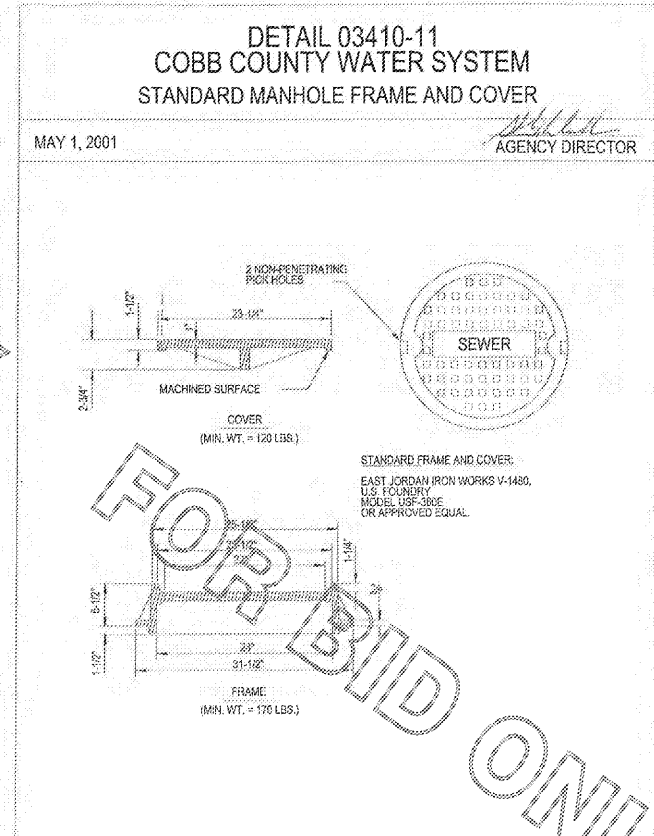

5 COBB COUNTY STANDARD UTILITY TRACER DETAIL

6 COBB COUNTY STANDARD MANHOLE DETAIL

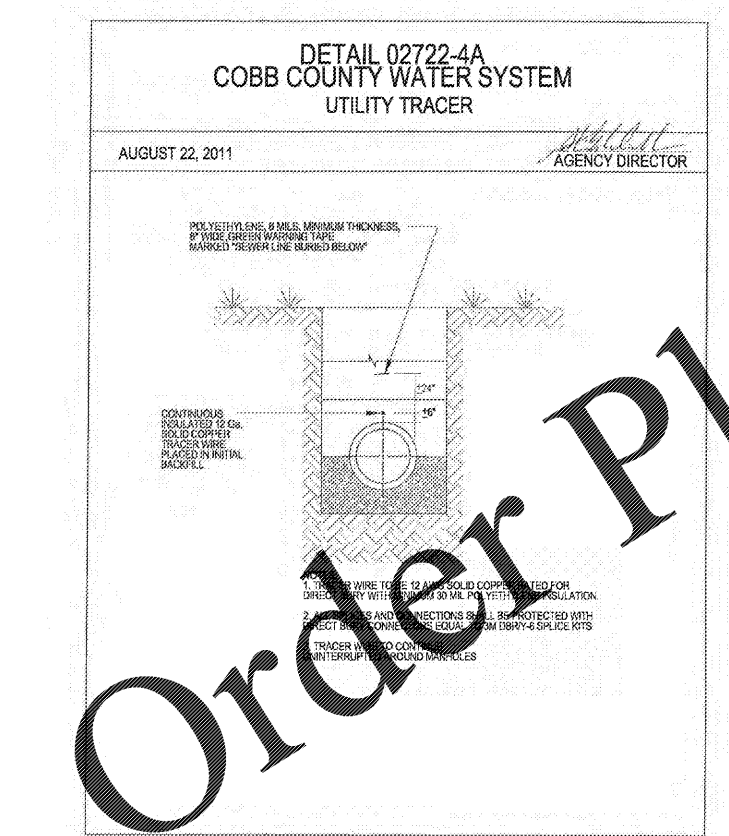

7 COBB COUNTY STANDARD MANHOLE FRAME AND COVER INSTALLATION DETAIL

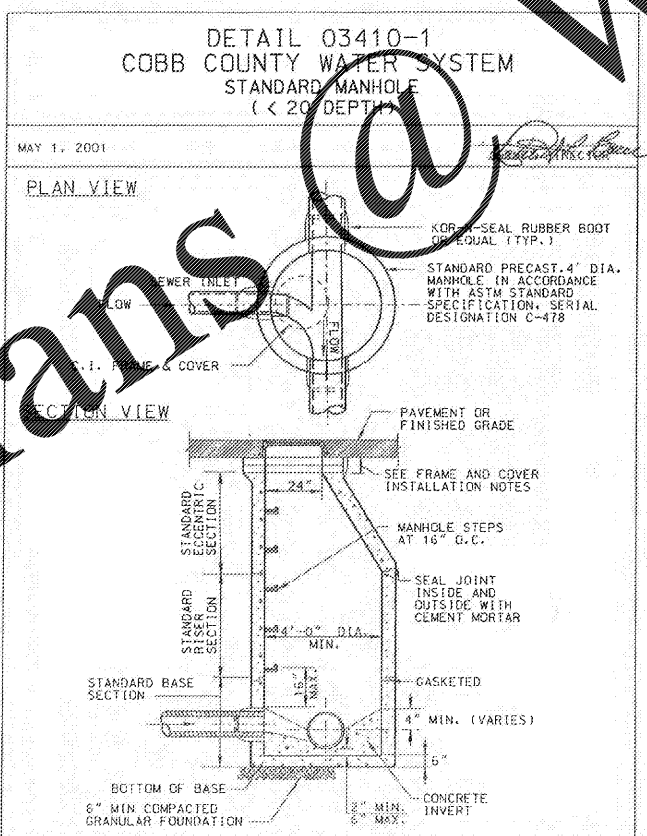

8 COBB COUNTY STANDARD MANHOLE FRAME AND COVER DETAIL

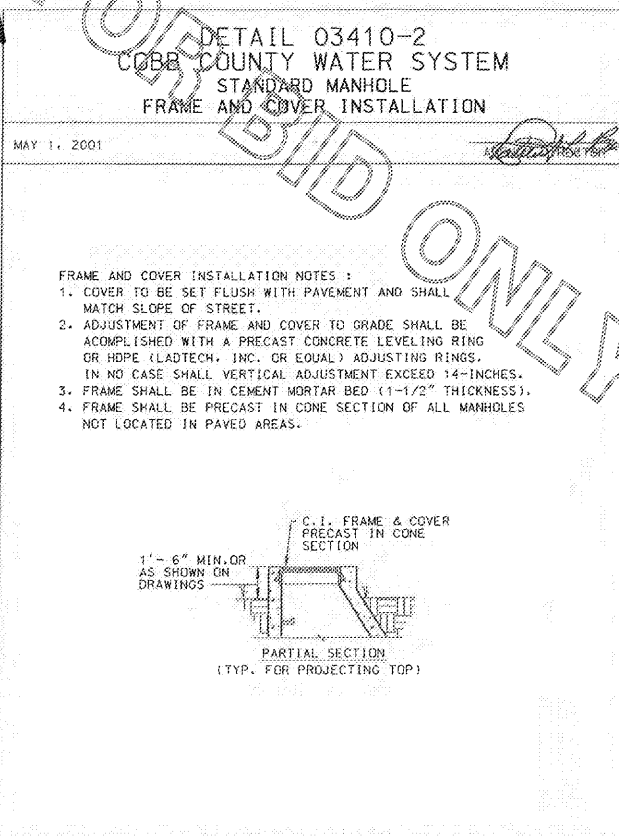

9 COBB COUNTY STANDARD UTILITY TRACER DETAIL

10 COBB COUNTY STANDARD MANHOLE DETAIL

Chick-fil-A

Chick-fil-A
5200 Buffington Road
Atlanta, Georgia 30349-2998

INTERPLANS

ARCHITECTURE
ENGINEERING
INTERIOR DESIGN
PROJECT MANAGEMENT

604 COURTLAND STREET
SUITE 100
ORLANDO, FLORIDA 32804
PH 407.645.5008
FX 407.629.9124

SEAL:
THIS DOCUMENT IS NOT FOR CONSTRUCTION
UNLESS THE ARCHITECT'S SIGNATURE AND SEAL APPEAR BELOW

STUART ANDERSON, P.E.
GA. REG. # PE038342

CHICK-FIL-A

SAR South Cobb FSR

3100 SOUTH COBB DRIVE SE.

SMYRNA, GEORGIA 30080

FSR# 0810

REVISION SCHEDULE

NO.	DATE	DESCRIPTION

CONSULTANT PROJECT # 2017.0165

PRINTED FOR Permit

DATE 10/20/17

DRAWN BY MJ

CHECKED BY GEG

Information contained on this drawing and in all digital files produced for above named project may not be reproduced in any manner without express written or verbal consent from authorized project representatives.

SHEET
COBB COUNTY
STANDARD DETAILS

SHEET NUMBER
C-5.1