

ALL FLOORS EXCEPT TOP FLOOR
TOP FLOOR HAS DRYER VENTS DOWN

8 TYPICAL DRYER DUCT CONNECTION
M-11 NOT TO SCALE

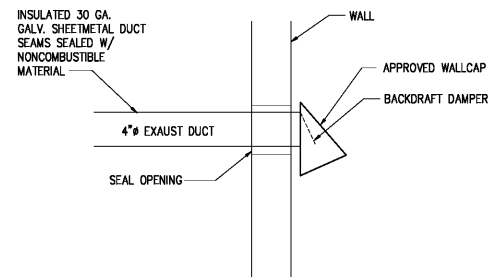

9 DRYER EXHAUST DUCT DETAIL
M-11 NOT TO SCALE

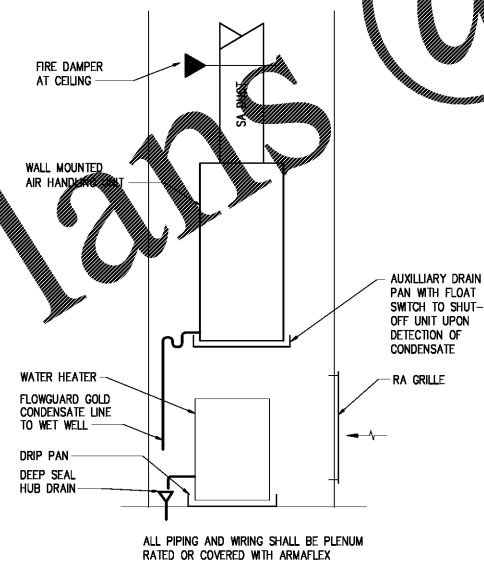

ALL PIPING AND WIRING SHALL BE PLENUM RATED OR COVERED WITH ARMAFLEX

10 APARTMENT AIR HANDLER DETAIL
M-11 NOT TO SCALE

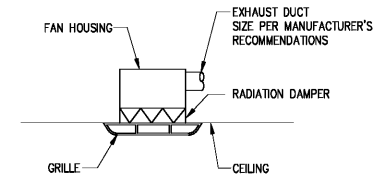

5 EF-B EXHAUST FAN DETAIL
M-11 NOT TO SCALE

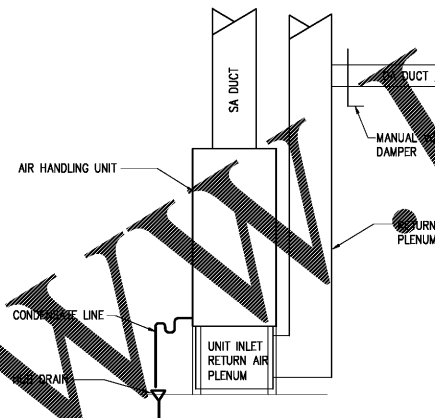

6 LEASING OFFICE AIR HANDLER DETAIL
M-11 NOT TO SCALE

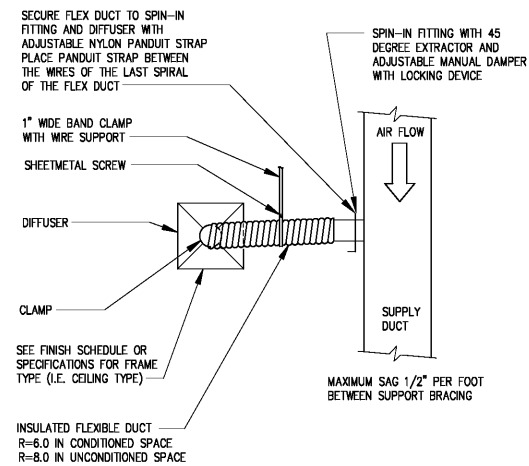

7 DIFFUSER CONNECTION DETAIL
M-11 NOT TO SCALE

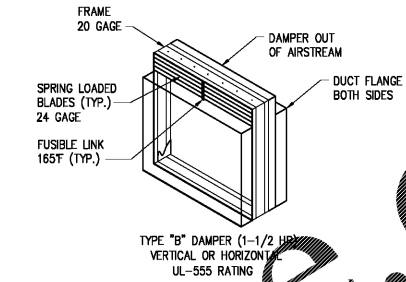

1 FIRE DAMPER ASSEMBLY
M-11 NOT TO SCALE

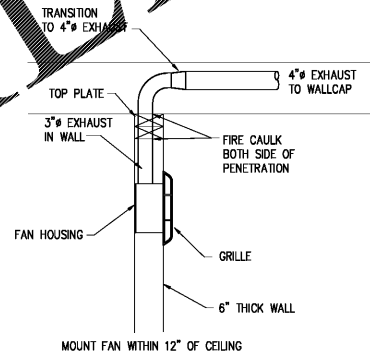

2 EF-A EXHAUST FAN DETAIL
M-11 NOT TO SCALE

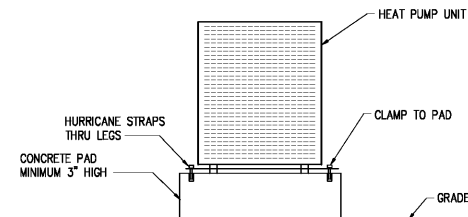

3 HEAT PUMP MOUNTING DETAIL
M-11 NOT TO SCALE

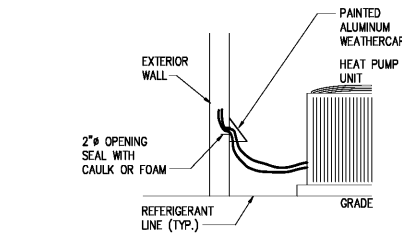

4 REFRIGERANT LINE ENTRY DETAIL
M-11 NOT TO SCALE

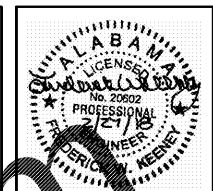

PUCCIANO & ENGLISH, INC.
ARCHITECTS, AIA
3084 MERCER UNIVERSITY DRIVE, SUITE 110
ATLANTA, GA 30341
PH 770-457-0623, FAX 770-451-0092
web@pucciano-english.com



JOB No: 1701
DRAWN BY: RK
CHECK BY: RK

JOB PROGRESS:
ITEM DATE
PRICING SET 07-14-2017
PERMIT SET 02-26-2018

REVISIONS:
DATE NO.

This drawing, as an instrument of service, is and shall remain the property of the Architect and shall not be reproduced, published or used in any way without the permission of the Architect.

Legacy at Jones Farm Phase 2
HUNTSVILLE, ALABAMA
AN APARTMENT COMMUNITY FOR
RBJ BAILEY, LLC

MECHANICAL DETAILS

SHEET NO.

M-11

Order Plans @

WWW.LDILLINE.COM