

Order Plans @

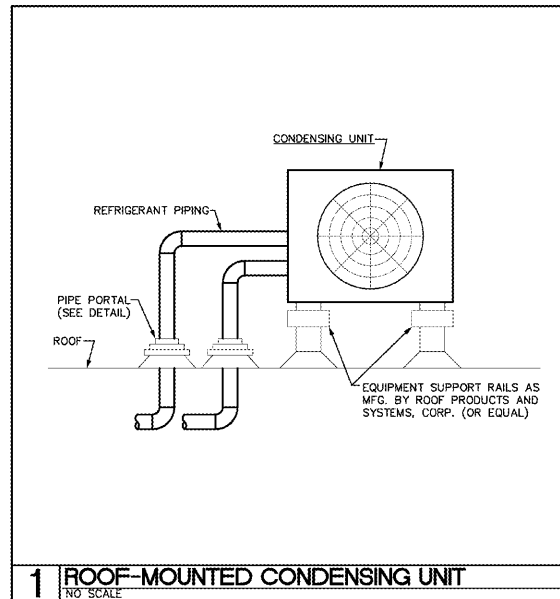

1 ROOF-MOUNTED CONDENSING UNIT  
NO SCALE

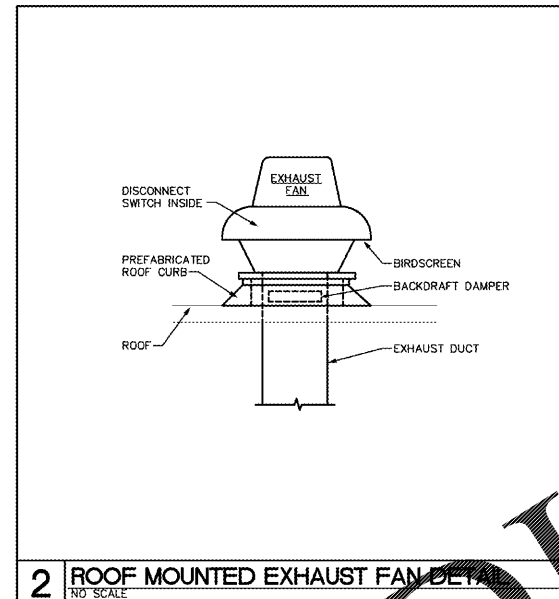

2 ROOF MOUNTED EXHAUST FAN DETAIL  
NO SCALE

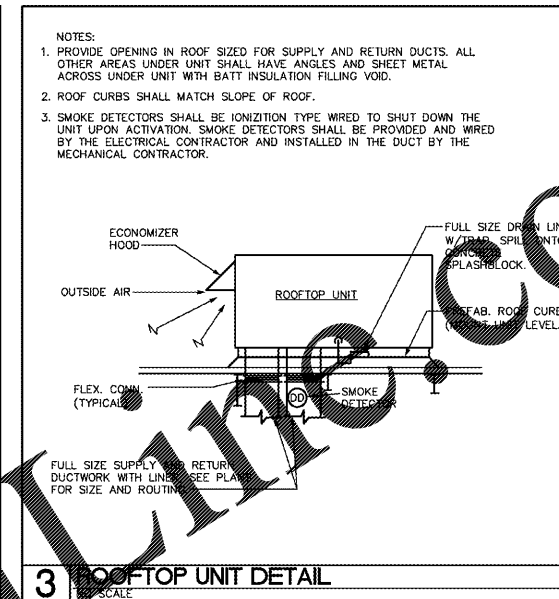

3 ROOFTOP UNIT DETAIL  
NO SCALE

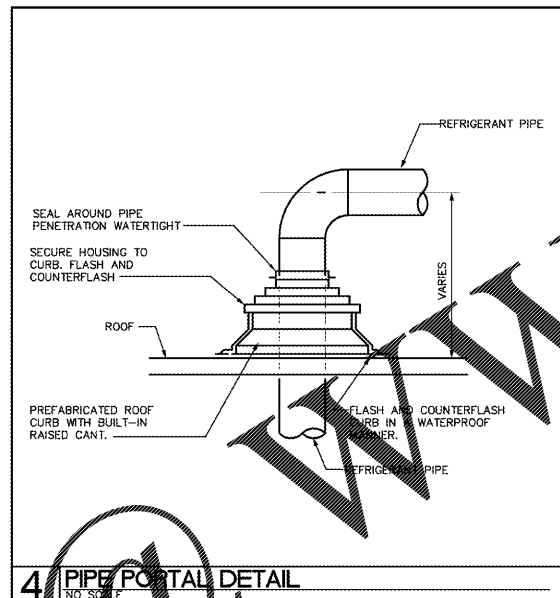

4 PIPE PORTAL DETAIL  
NO SCALE

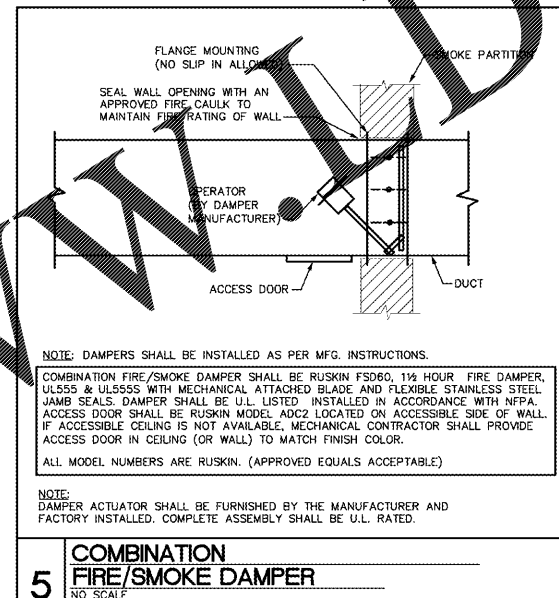

5 COMBINATION FIRE/SMOKE DAMPER  
NO SCALE

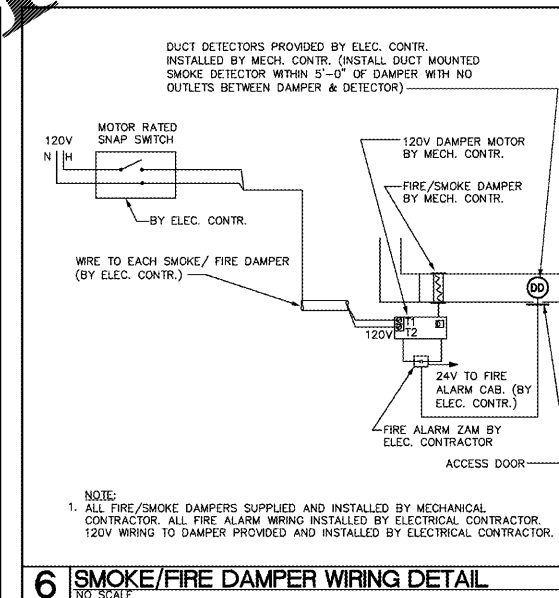

6 SMOKE/FIRE DAMPER WIRING DETAIL  
NO SCALE

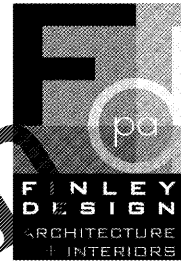

FINLEY DESIGN PA  
7806 NC HWY 751  
SUITE 110  
DURHAM, NC 27713  
P 919-493-8200  
F 919-493-8113  
FINLEYDESIGNARCH.COM

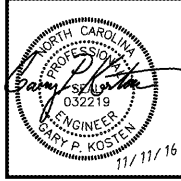

WESTPOINT 2  
DURHAM, NC

REVISIONS

PROJECT: 1342  
DATE: 11/11/16  
DRAWN BY: ECC  
CHECKED BY: GPK

MECHANICAL  
DETAILS  
M3.2  
13 OF 14