

**WAWA PLANTER DETAILS**

REV. JULY 28, 2016

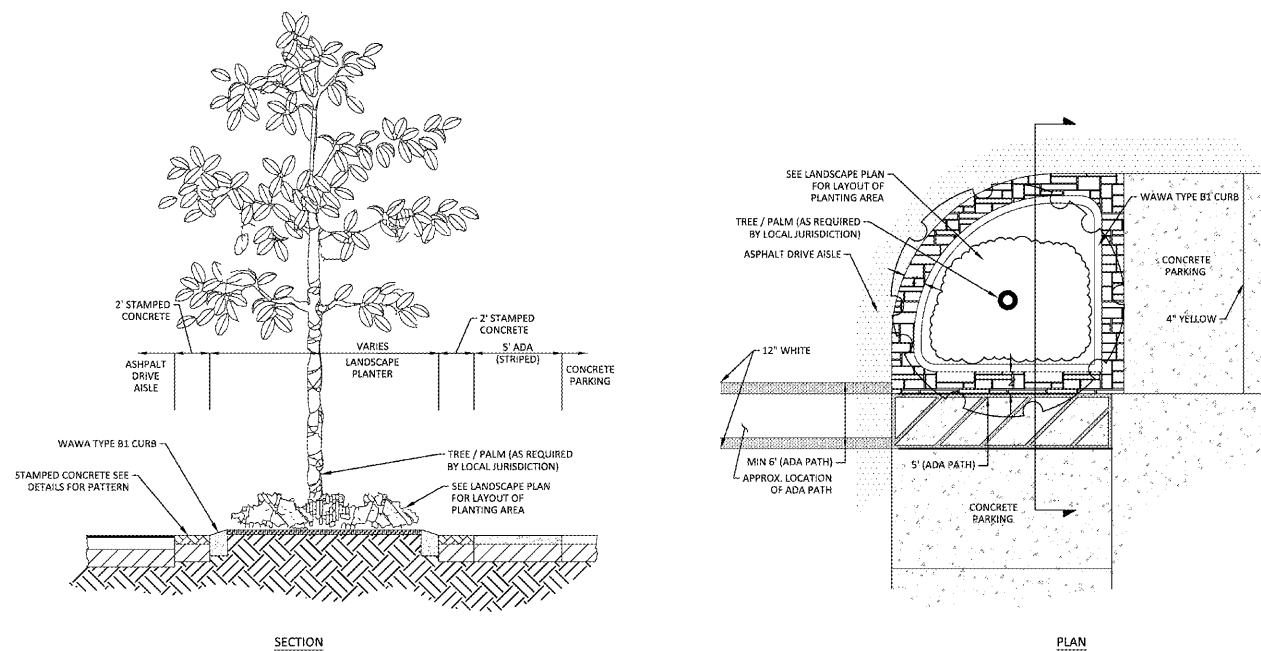

**CORNER ISLAND LANDSCAPE DETAIL**

NTS

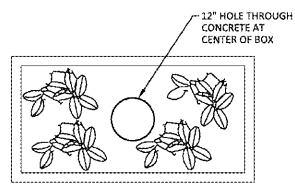

**PLANTER BOX DRAINAGE DETAIL**

NTS

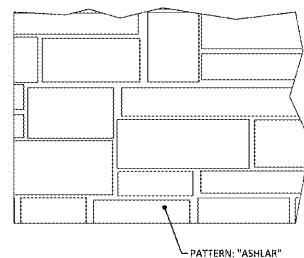

**STAMPED STANDARD DUTY CONCRETE DETAIL**

- NOTES:**
- SEE STANDARD DUTY PAVEMENT SECTION FOR PAVEMENT DETAILS.
  - FINAL COLOR TO BE COORDINATED WITH WAWA PRIOR TO INSTALLATION.
  - THE STAMPED CONCRETE FIELD IS "ASHLAR" PATTERN. USE INCRETE COLOR-INTEGRATED CONCRETE "DESERT TAN" WITH THE FOLLOWING STEP-BY-STEP TREATMENT:
    - 100% BROADCAST DRY SHAKE HARDENER "DESERT TAN", FOLLOWED BY:
    - 30%-35% BROADCAST DRY SHAKE HARDENER "COCOA", THEN HARD TROWEL.
    - USE RELEASE POWDER "EACH" IN MOLD. KEEP SOME OF THE COLOR IN GROUT JOINTS AND HIGHLIGHTS.
    - USE PENETRATING, NON-GLOSSY SEALER SUCH AS CLEAR SEAL BY INCRETE SYSTEMS.

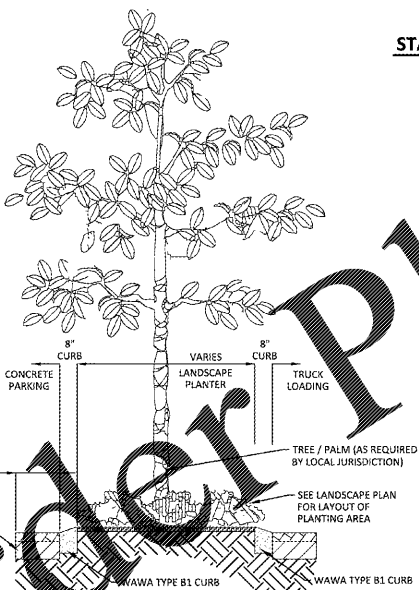

**PARKING ISLAND LANDSCAPE DETAIL**

NTS

**WAWA PAVEMENT DETAILS**

REV. JULY 28, 2016

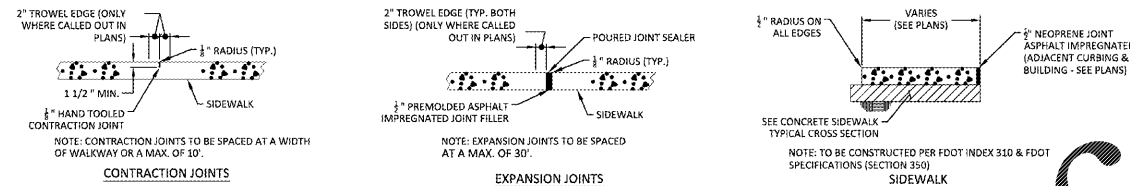

**SIDEWALK DETAILS**

NTS

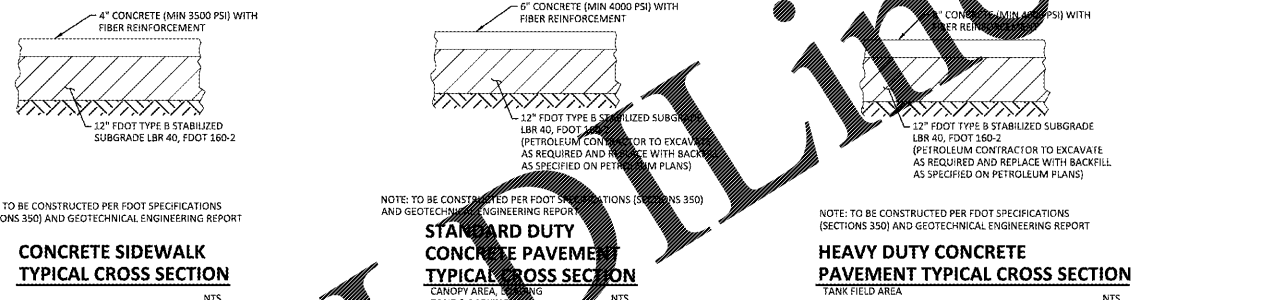

**CONCRETE SIDEWALK TYPICAL CROSS SECTION**

NTS

**STANDARD DUTY CONCRETE PAVEMENT TYPICAL CROSS SECTION**

NTS

**HEAVY DUTY CONCRETE PAVEMENT TYPICAL CROSS SECTION**

NTS

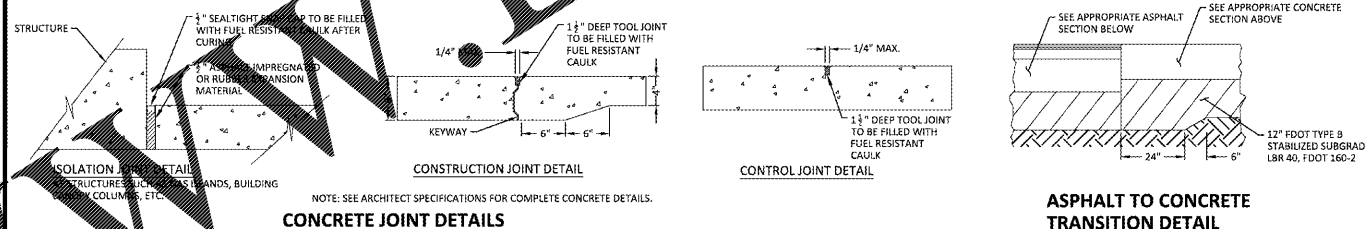

**CONCRETE JOINT DETAILS**

NTS

**ASPHALT TO CONCRETE TRANSITION DETAIL**

NTS

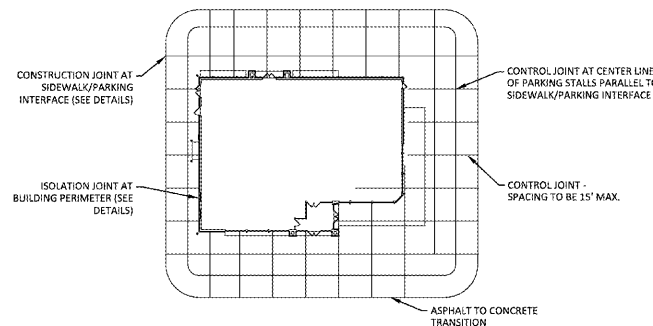

**JOINT LAYOUT DETAIL**

NTS

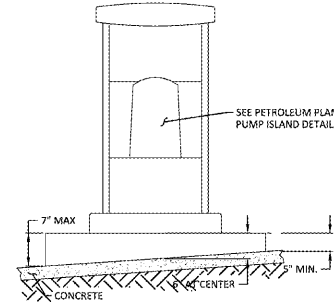

**PUMP ISLAND GRADING DETAIL**

NTS

**STANDARD DUTY ASPHALT PAVEMENT OPTIONS: SELECT ONE. TO BE DETERMINED BY SITE GEOTECHNICAL ENGINEER**

- FOR SANDY AND GRAVEL SUB-GRADES CAPABLE OF ACHIEVING A LBR OF 10 OR GREATER (SN OF 2.60)
- FOR CLAY AND SILTY SUB-GRADES CAPABLE OF ACHIEVING A LBR VALUE OF 6 TO 10 (SN OF 3.04)
- FOR SUB-GRADES CAPABLE OF ACHIEVING A LBR OF LESS THAN 6 (SN OF 3.30)

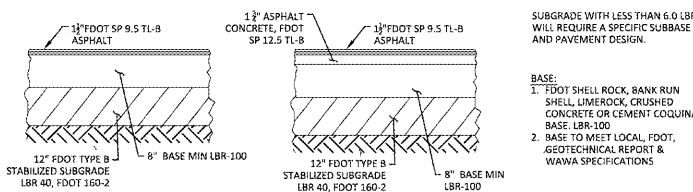

**STANDARD DUTY ASPHALT PAVEMENT TYPICAL CROSS SECTION**

NTS

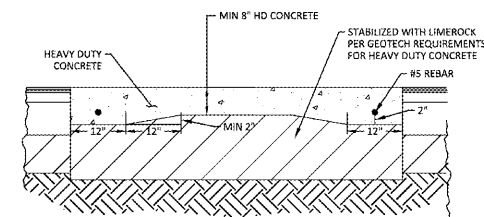

**CONCRETE CROSSWALK DETAIL**

NTS

**Bowman CONSULTING**  
 Certificate of Authorization License No. 30482

Bowman Consulting Group, Ltd.  
 One Urban Centre  
 4850 W. Kennedy Blvd.  
 Suite 600  
 Tampa, FL 33609  
 Phone: (813) 509-5403  
 www.bowmanconsulting.com  
 © Bowman Consulting Group, Ltd.

**WAWA STANDARD DETAILS**  
 WAWA  
 COUNTRYSIDE BLVD & U.S. HWY 19  
 CLEARWATER, PINELLAS COUNTY  
 FLORIDA

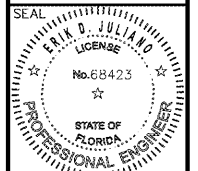

ERIK D. JULIANO, P.E.  
 LICENSE NO. 68423  
 05/24/2017

**PLAN STATUS**

02/10/17	FDOT ACCESS REVIEW
03/09/17	CITY REVIEW
05/16/17	CITY REVIEW

DATE	DESCRIPTION
JM	JM
DESIGN	DRAWN
SCALE	AS SHOWN
JOB No.	010455-01-002
DATE	05/24/2017
FILE	C-9.0 DETAILS.DWG

THIS DOCUMENT, TOGETHER WITH THE CONCEPTS AND DESIGN PRESENTED HEREIN, IS INSTRUMENT OF SERVICE. IT IS HEREBY AGREED AND UNDERSTOOD BY ALL PARTIES THAT THE CONSULTANT SHALL BE WITHOUT LIABILITY TO BOWMAN CONSULTING, INC. FOR ANY AND ALL DAMAGES, INCLUDING REASONABLE ATTORNEY'S FEES, THAT MAY BE INCURRED BY ANY PARTY AS A RESULT OF THE CONSULTANT'S NEGLIGENCE OR MALPRACTICE IN THE PERFORMANCE OF ITS PROFESSIONAL SERVICES. THE CONSULTANT'S LIABILITY SHALL BE LIMITED TO THE AMOUNT OF THE FEE PAID TO THE CONSULTANT FOR THE SERVICES PROVIDED. THIS LIMITATION OF LIABILITY SHALL NOT BE WAIVED BY ANY OTHER AGREEMENT, INCLUDING ANY AGREEMENT MADE BY ANY PARTY TO THIS AGREEMENT. THE CONSULTANT'S LIABILITY SHALL BE LIMITED TO THE AMOUNT OF THE FEE PAID TO THE CONSULTANT FOR THE SERVICES PROVIDED. THIS LIMITATION OF LIABILITY SHALL NOT BE WAIVED BY ANY OTHER AGREEMENT, INCLUDING ANY AGREEMENT MADE BY ANY PARTY TO THIS AGREEMENT.

Order Plans @

WAWA ONLINE.COM