

**WAWA SIGNAGE/STRIPING DETAILS**

REV. JULY 28, 2016

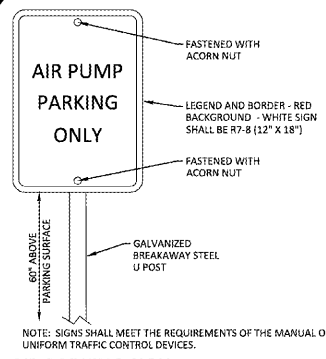

**NOTES:**  
 1. ALL LETTERS ARE 1" SERIES "C" PER MUTCD.  
 2. TOP PORTION OF SIGN SHALL HAVE A REFLECTORIZED (ENGINEERING GRADE) BLUE BACKGROUND WITH WHITE REFLECTORIZED LEGEND AND BORDER.  
 3. BOTTOM PORTION OF SIGN SHALL HAVE A REFLECTORIZED (ENGINEERING GRADE) WHITE BACKGROUND WITH BLACK OPAQUE LEGEND AND BORDER.  
 4. FINE NOTIFICATION SIGN SHALL HAVE A REFLECTORIZED (ENGINEERING GRADE) WHITE BACKGROUND WITH BLACK OPAQUE LEGEND & BORDER. CONTRACTOR SHALL VERIFY FINE AMOUNT & ORD. NO.  
 5. ONE(1) SIGN REQUIRED FOR EACH PARKING SPACE.  
 6. INSTALLATION HEIGHT OF SIGN SHALL BE 60" ABOVE THE FINISHED GRADE TO THE BOTTOM OF THE SIGN, ON UNIFORM TRAFFIC CONTROL DEVICES (MUTCD).  
 7. SIGN POST TO BE GALVANIZED BREAKAWAY STEEL U POST.  
 8. SIGN TO BE FASTENED TO POST WITH ACORN NUT.

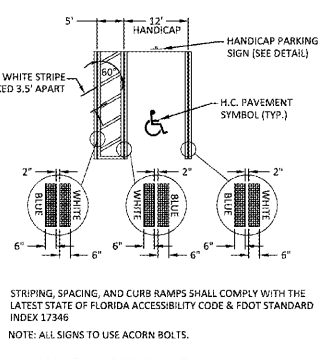
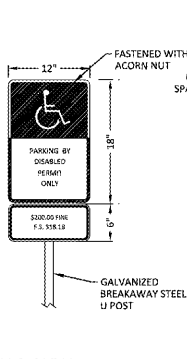

**AIR PARKING SIGN**  
NTS

**HANDICAP PARKING SIGN**  
NTS

**HANDICAP STRIPING DETAIL**  
NTS

**SIGNAGE AND STRIPING NOTES:**  
 1. ALL STANDARD PARKING STRIPES ARE TO BE PER CURRENT MUTCD AND CITY STANDARDS.  
 2. ARROWS SHOWN IN DRIVE AISLES ARE FOR INFORMATION ONLY AND SHALL NOT BE PAINTED.

**WAWA GENERAL DETAILS**

REV. JULY 28, 2016

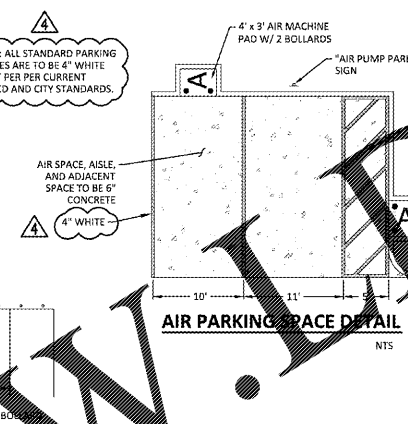
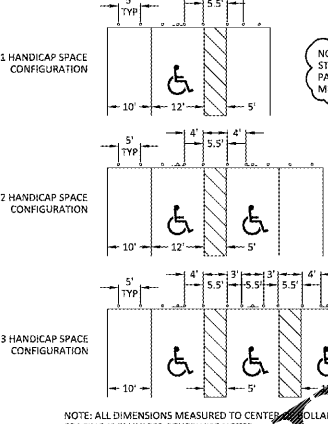
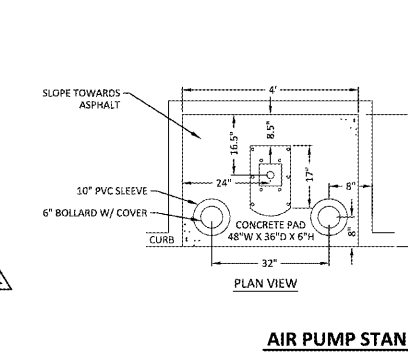
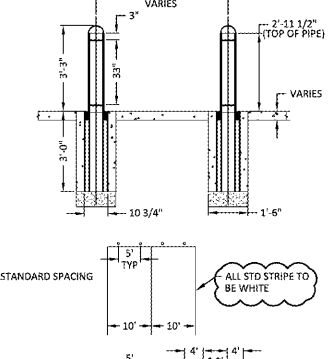

**STANDARD SPACING**  
NTS

**AIR PUMP STAND**  
NTS

**AIR PUMP SPACE DETAIL**  
NTS

**BOLLARD SPACING/DIMENSION DETAIL**  
NTS

**WAWA CURB DETAILS**

REV. JULY 28, 2016

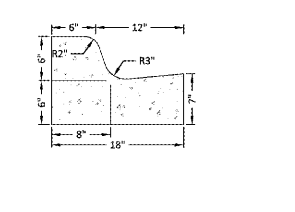
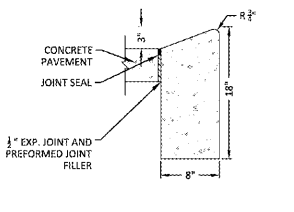

**WAWA TYPE B1 CURB**  
NTS

**WAWA TYPE F1 CURB**  
NTS

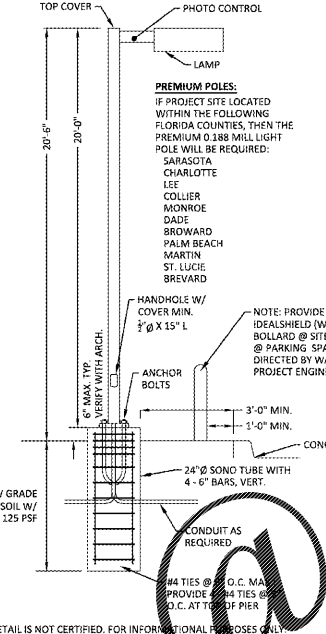

**LIGHT POLE WITH STANDARD ANCHORING DETAIL**  
NTS

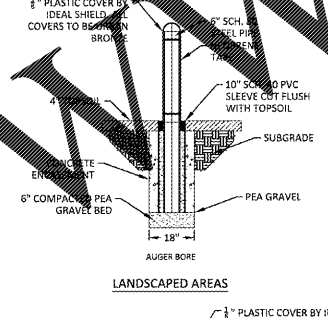

**LANDSCAPED AREAS**  
NTS

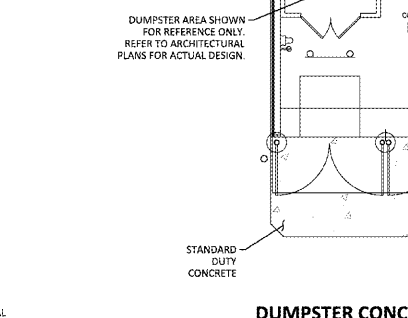

**DUMPSTER CONCRETE APRON**  
NTS

**WAWA DRAINAGE DETAILS**

REV. JULY 28, 2016

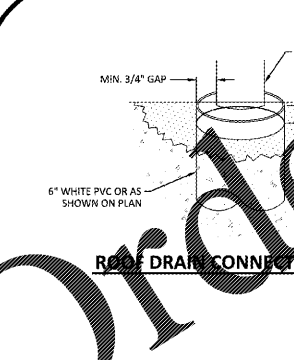

**ROOF DRAIN CONNECTION DETAIL**  
NTS

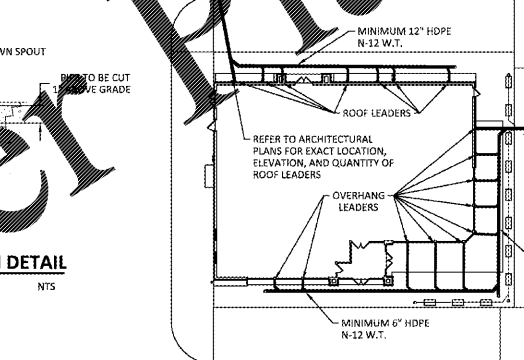

**ROOF DRAIN MANIFOLD DETAIL**  
NTS

**NOTES:**  
 1. ENGINEER TO SPECIFY ACTUAL PIPE SIZE PER HYDRAULIC CALCULATIONS.  
 2. SITE CONTRACTOR TO BUILD LINES TO INDIVIDUAL WYE FITTINGS.  
 3. PLANTER DRAINS ARE TO CONNECT TO MAINFOLD.

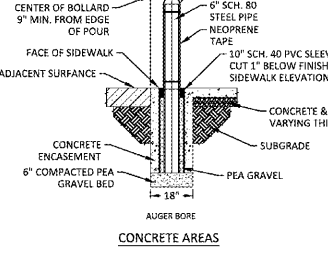

**CONCRETE AREAS**  
NTS

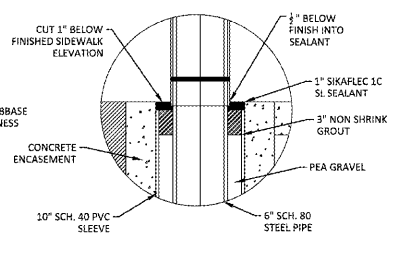

**GENERAL DETAILS AND CAULK/GROUT DETAIL FOR CONCRETE AREAS**  
NTS

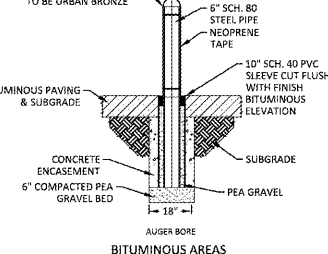

**BITUMINOUS AREAS**  
NTS

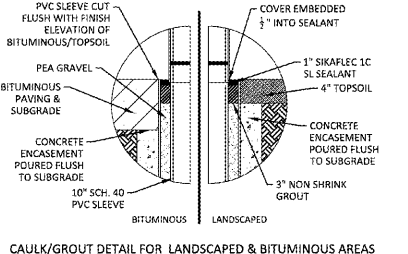

**CAULK/GROUT DETAIL FOR LANDSCAPED & BITUMINOUS AREAS**  
NTS

**WAWA BOLLARD DETAILS**

REV. JULY 28, 2016

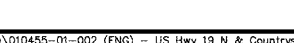

**BOLLARD DETAIL**  
NTS

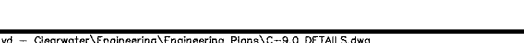

**EMERGENCY PUMP SHUTOFF DETAIL**  
NTS

**WAWA ADA DETECTABLE CURB WARNING DETAILS**

REV. JULY 28, 2016

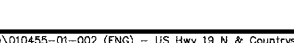

**ADA DETECTABLE CURB WARNING DETAIL**  
NTS

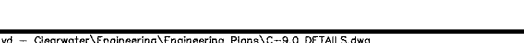

**STANDARD BICYCLE RACK DETAIL**  
NTS

**WAWA AIR PUMP STAND DETAILS**

REV. JULY 28, 2016

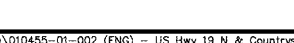

**AIR PUMP STAND**  
NTS

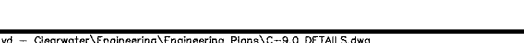

**DUMPSTER CONCRETE APRON**  
NTS

**WAWA BOLLARD SPACING/DIMENSION DETAILS**

REV. JULY 28, 2016

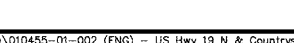

**BOLLARD SPACING/DIMENSION DETAIL**  
NTS

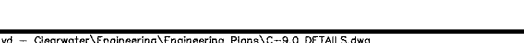

**STANDARD BICYCLE RACK DETAIL**  
NTS

**WAWA AIR PUMP SPACE DETAILS**

REV. JULY 28, 2016

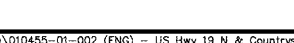

**AIR PUMP SPACE DETAIL**  
NTS

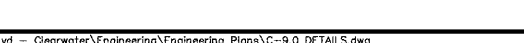

**LANDSCAPED AREAS**  
NTS

**WAWA CONCRETE AREAS**

REV. JULY 28, 2016

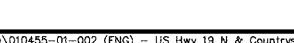

**CONCRETE AREAS**  
NTS

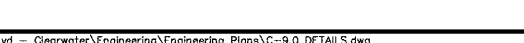

**GENERAL DETAILS AND CAULK/GROUT DETAIL FOR CONCRETE AREAS**  
NTS

**WAWA BITUMINOUS AREAS**

REV. JULY 28, 2016

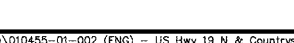

**BITUMINOUS AREAS**  
NTS

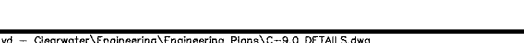

**CAULK/GROUT DETAIL FOR LANDSCAPED & BITUMINOUS AREAS**  
NTS

**WAWA EMERGENCY PUMP SHUTOFF DETAILS**

REV. JULY 28, 2016

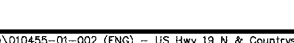

**EMERGENCY PUMP SHUTOFF DETAIL**  
NTS

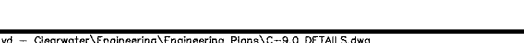

**ADA DETECTABLE CURB WARNING DETAIL**  
NTS

**WAWA STANDARD BICYCLE RACK DETAILS**

REV. JULY 28, 2016

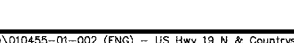

**STANDARD BICYCLE RACK DETAIL**  
NTS

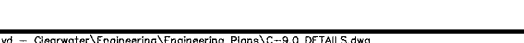

**AIR PUMP STAND**  
NTS

**WAWA DUMPSTER CONCRETE APRON DETAILS**

REV. JULY 28, 2016

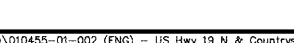

**DUMPSTER CONCRETE APRON**  
NTS

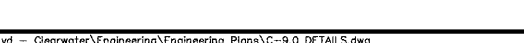

**LANDSCAPED AREAS**  
NTS

**WAWA CONCRETE AREAS**

REV. JULY 28, 2016

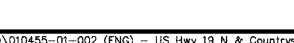

**CONCRETE AREAS**  
NTS

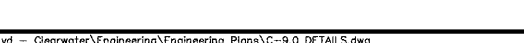

**GENERAL DETAILS AND CAULK/GROUT DETAIL FOR CONCRETE AREAS**  
NTS

**WAWA BITUMINOUS AREAS**

REV. JULY 28, 2016

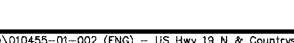

**BITUMINOUS AREAS**  
NTS

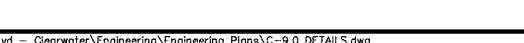

**CAULK/GROUT DETAIL FOR LANDSCAPED & BITUMINOUS AREAS**  
NTS

**WAWA EMERGENCY PUMP SHUTOFF DETAILS**

REV. JULY 28, 2016

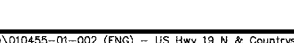

**EMERGENCY PUMP SHUTOFF DETAIL**  
NTS

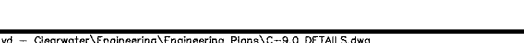

**ADA DETECTABLE CURB WARNING DETAIL**  
NTS

**WAWA STANDARD BICYCLE RACK DETAILS**

REV. JULY 28, 2016

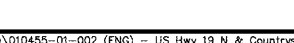

**STANDARD BICYCLE RACK DETAIL**  
NTS

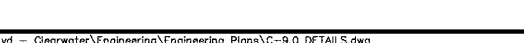

**AIR PUMP STAND**  
NTS

**WAWA DUMPSTER CONCRETE APRON DETAILS**

REV. JULY 28, 2016

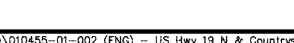

**DUMPSTER CONCRETE APRON**  
NTS

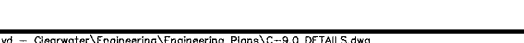

**LANDSCAPED AREAS**  
NTS

**WAWA CONCRETE AREAS**

REV. JULY 28, 2016

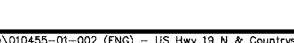

**CONCRETE AREAS**  
NTS

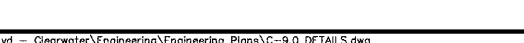

**GENERAL DETAILS AND CAULK/GROUT DETAIL FOR CONCRETE AREAS**  
NTS

**WAWA BITUMINOUS AREAS**

REV. JULY 28, 2016

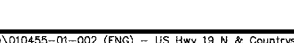

**BITUMINOUS AREAS**  
NTS

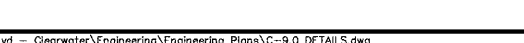

**CAULK/GROUT DETAIL FOR LANDSCAPED & BITUMINOUS AREAS**  
NTS

**WAWA EMERGENCY PUMP SHUTOFF DETAILS**

REV. JULY 28, 2016

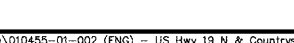

**EMERGENCY PUMP SHUTOFF DETAIL**  
NTS

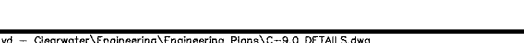

**ADA DETECTABLE CURB WARNING DETAIL**  
NTS

**WAWA STANDARD BICYCLE RACK DETAILS**

REV. JULY 28, 2016

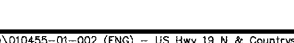

**STANDARD BICYCLE RACK DETAIL**  
NTS

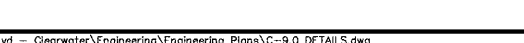

**AIR PUMP STAND**  
NTS

**WAWA DUMPSTER CONCRETE APRON DETAILS**

REV. JULY 28, 2016

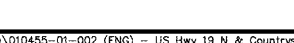

**DUMPSTER CONCRETE APRON**  
NTS

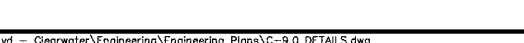

**LANDSCAPED AREAS**  
NTS

**WAWA CONCRETE AREAS**

REV. JULY 28, 2016

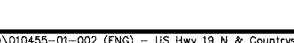

**CONCRETE AREAS**  
NTS

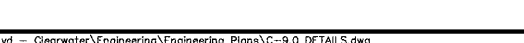

**GENERAL DETAILS AND CAULK/GROUT DETAIL FOR CONCRETE AREAS**  
NTS

**WAWA BITUMINOUS AREAS**

REV. JULY 28, 2016

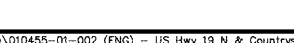

**BITUMINOUS AREAS**  
NTS

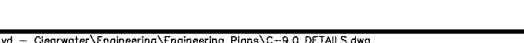

**CAULK/GROUT DETAIL FOR LANDSCAPED & BITUMINOUS AREAS**  
NTS

**WAWA EMERGENCY PUMP SHUTOFF DETAILS**

REV. JULY 28, 2016

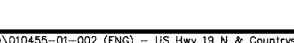

**EMERGENCY PUMP SHUTOFF DETAIL**  
NTS

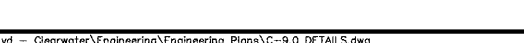

**ADA DETECTABLE CURB WARNING DETAIL**  
NTS

**WAWA STANDARD BICYCLE RACK DETAILS**

REV. JULY 28, 2016

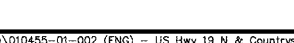

**STANDARD BICYCLE RACK DETAIL**  
NTS

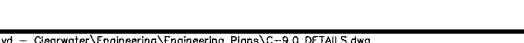

**AIR PUMP STAND**  
NTS

**WAWA DUMPSTER CONCRETE APRON DETAILS**

REV. JULY 28, 2016

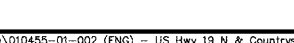

**DUMPSTER CONCRETE APRON**  
NTS

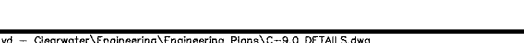

**LANDSCAPED AREAS**  
NTS

**WAWA CONCRETE AREAS**

REV. JULY 28, 2016

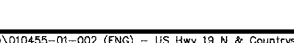

**CONCRETE AREAS**  
NTS

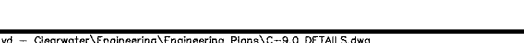

**GENERAL DETAILS AND CAULK/GROUT DETAIL FOR CONCRETE AREAS**  
NTS

**WAWA BITUMINOUS AREAS**

REV. JULY 28, 2016

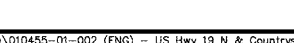

**BITUMINOUS AREAS**  
NTS

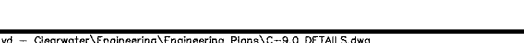

**CAULK/GROUT DETAIL FOR LANDSCAPED & BITUMINOUS AREAS**  
NTS

**WAWA EMERGENCY PUMP SHUTOFF DETAILS**

REV. JULY 28, 2016

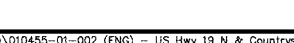

**EMERGENCY PUMP SHUTOFF DET**