

Order Plans

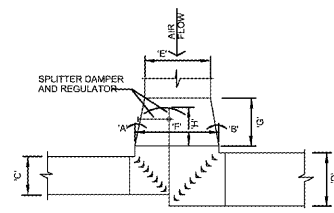

- DIMENSIONAL RELATIONSHIP**
1. ANGLES 'A' & 'B' EACH TO BE 15 DEGREES OR LESS
 2. SEE FLOOR PLANS FOR VALUES FOR 'C', 'D' & 'E'
 3. 'F' = 'C' + 'D'
 4. 'F' = 1.5 x 'C'
 5. 'D' = 'H' - 2" MINIMUM
 6. HEIGHT OF FITTING EQUAL TO THAT OF HIGHEST OF THE THREE DUCTS
 7. CHANGE IN HEIGHTS OF DOWNSTREAM DUCTS TO OCCUR AFTER THE TURN/FOUR CORNERS

2B SPLITTER TEE DETAIL N.T.S.

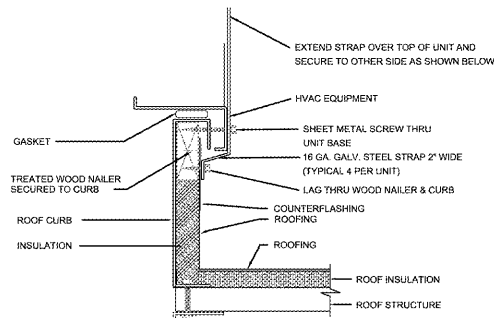

G.C. TO SECURE UNIT PER MANUFACTURERS RECOMMENDATIONS REFER TO 2E/A302

NOTE: REFER TO ARCHITECTURAL DRAWINGS FOR ROOFING DETAILS.

3B ROOFTOP CURB DETAIL N.T.S.

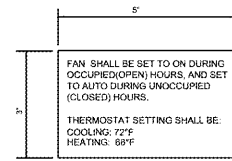

1. SIGN TO BE FABRICATED FROM LAMACOID PLASTIC WITH BLACK OUTER LAMINATIONS AND A WHITE INNER LAMINATION.
2. LETTERS SHALL BE 1/4" HIGH UPPER CASE ENGRAVED LETTERS TO EXPOSE THE WHITE LAMINATION, WORDING TO BE THE SAME AS SHOWN ABOVE.
3. EACH LINE OF LETTERING TO BE CENTERED ON SIGN.
4. INSTALL SIGN NEAR THERMOSTAT IN A PROMINENT PLACE AS DIRECTED BY OWNER'S CONSTRUCTION MANAGER. REMOVE ALL PAINT AND CLEAN MOUNTING SURFACE FOR MOUNTING SIGN WITH A CONTACT GEMET.

4B THERMOSTAT SETTING DETAIL N.T.S.

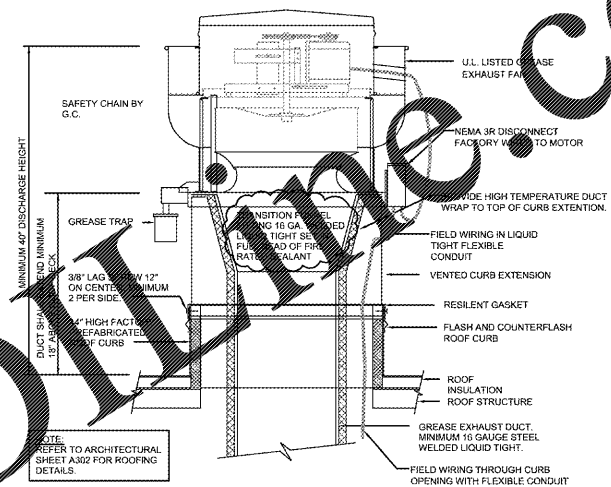

6B KITCHEN EXHAUST FAN DETAIL N.T.S.

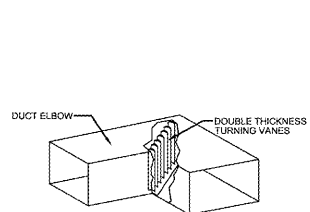

1C MITERED ELBOW DETAIL N.T.S.

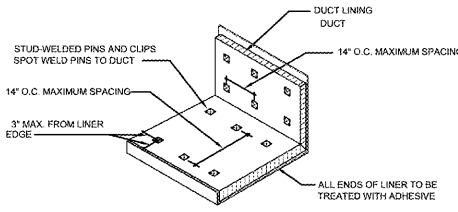

2C ACOUSTIC DUCT LINER DETAIL N.T.S.

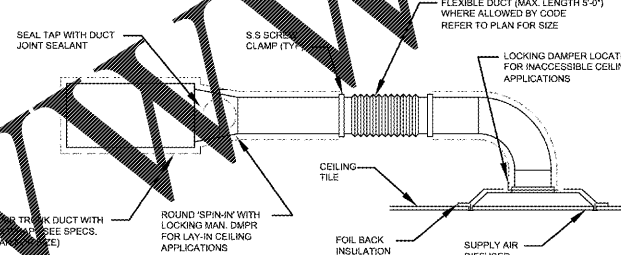

4C DIFFUSER CONNECTION DETAIL N.T.S.

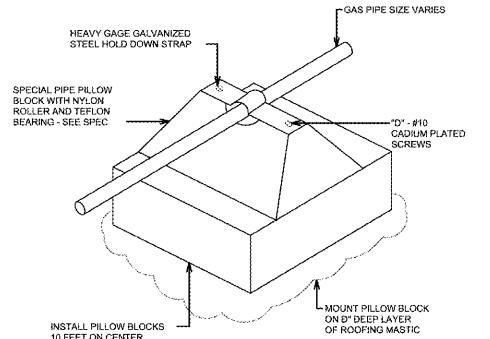

6C GAS PIPE ROOF SUPPORT DETAIL N.T.S.

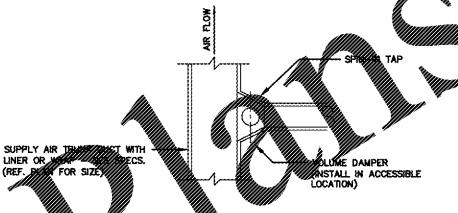

2D SPIN-IN TAP DETAIL N.T.S.

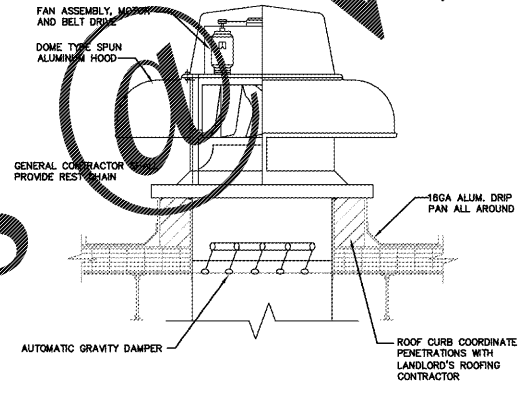

3D ROOF MOUNTED EXHAUST FAN DETAIL N.T.S.

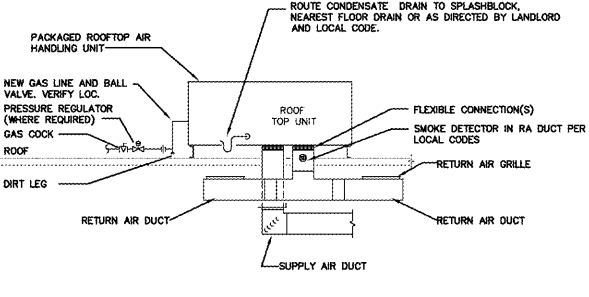

5D ROOF TOP UNIT SECTION N.T.S.

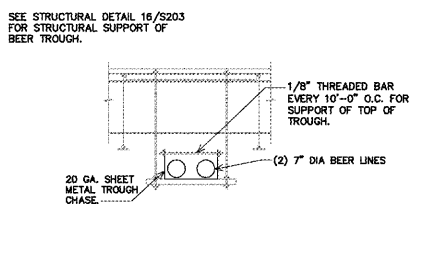

6D BEER LINE TROUGH DETAIL N.T.S.



PROJECT NUMBER 5748

BUFFALO WILD WINGS
BIRMINGHAM
1416 4th AVENUE SOUTH,
BIRMINGHAM, AL 35233



DRAWING ISSUE		DATE
NO.	DESCRIPTION	
1		
2		
3		
4		
5		
6		
7		

Drawing Title
MECHANICAL PLAN DETAILS

M102