

**STAINLESS STEEL CORNER GUARD**  
DATE: 7/29/13  
SCALE: NONE  
DRAWN: TMW  
MASTER SPECIFICATION DETAIL  
ASD--55A

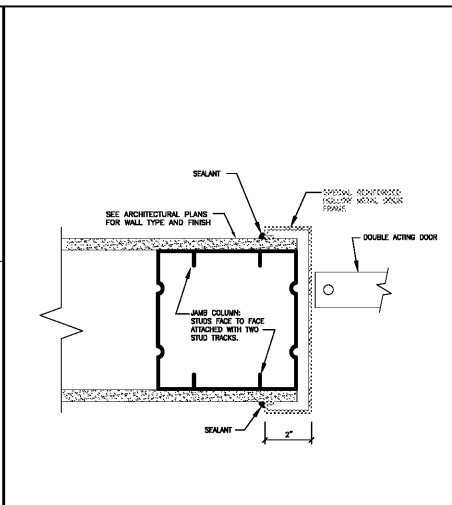

**DOUBLE ACTING DOOR FRAME AT STUD PARTITION**  
DATE: 8/7/13  
SCALE: NONE  
DRAWN: ZAW  
MASTER SPECIFICATION DETAIL  
ASD--56

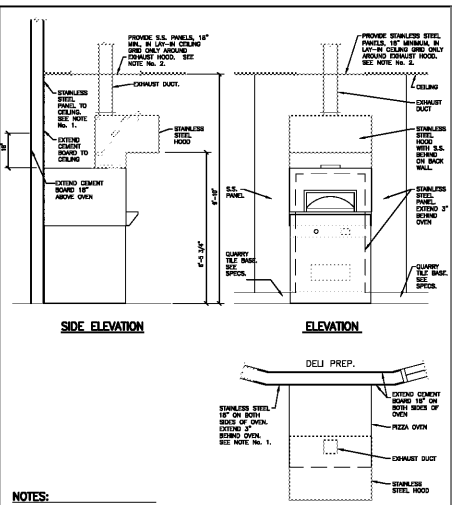

**PIZZA OVEN STANDARD - S.S. FINISH**  
DATE: 3/6/17  
SCALE: NONE  
DRAWN: ZAW  
MASTER SPECIFICATION DETAIL  
ASD--61

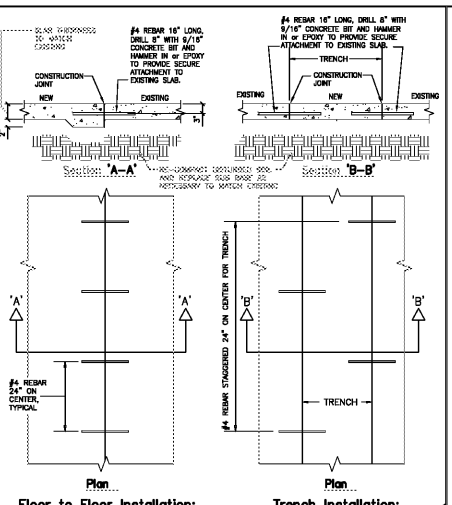

**CONCRETE FLOOR REPLACEMENT AT EXISTING**  
DATE: 10/1/09  
SCALE: NONE  
DRAWN: ZAW  
MASTER SPECIFICATION DETAIL  
ASD--62

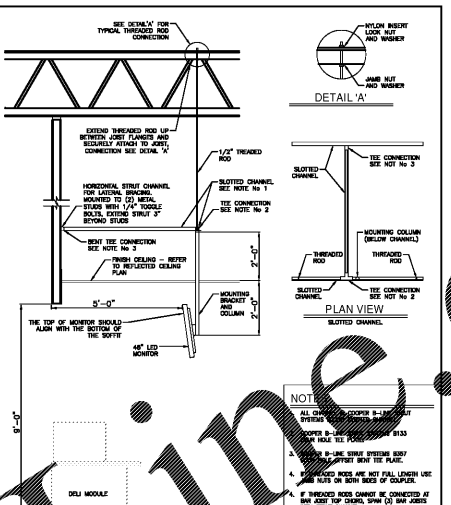

**DELI MONITOR MOUNTING**  
DATE: 9/6/18  
SCALE: NONE  
DRAWN: TMW  
MASTER SPECIFICATION DETAIL  
ASD--72

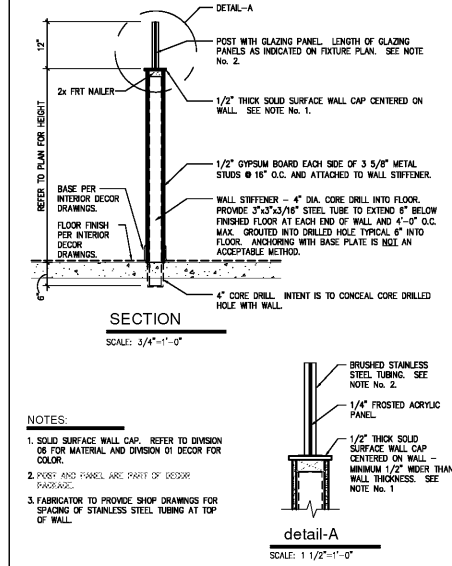

**SUSHI-DELI SEATING AREA LOW WALL**  
DATE: 3/24/17  
SCALE: NONE  
DRAWN: ZAW  
MASTER SPECIFICATION DETAIL  
ASD--73A

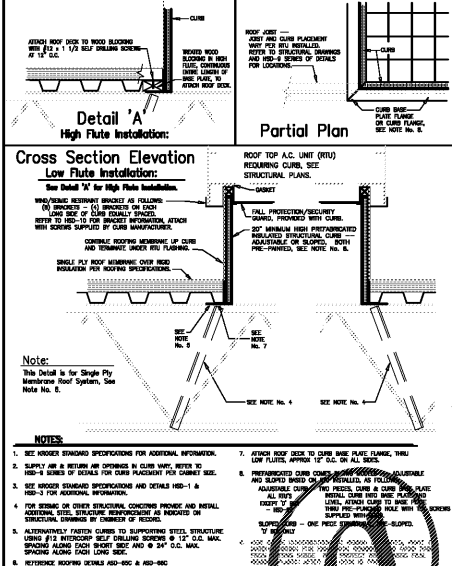

**PREFABRICATED FAN CURB**  
DATE: 11/10/16  
SCALE: NONE  
DRAWN: ZAW  
MASTER SPECIFICATION DETAIL  
ASD--78

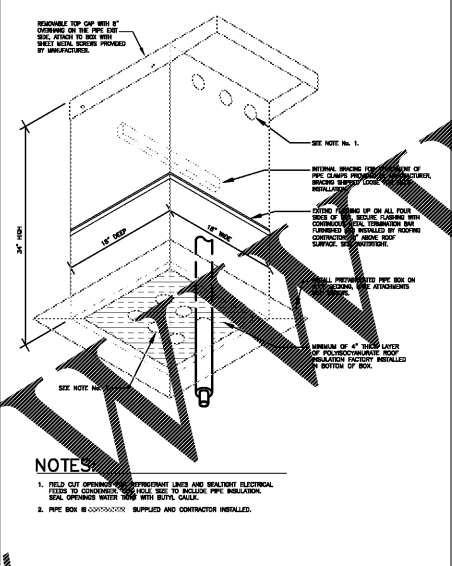

**PREFABRICATED SHEET METAL BOX FOR MECHANICAL PIPING**  
DATE: 5/13/13  
SCALE: NONE  
DRAWN: ZAW  
MASTER SPECIFICATION DETAIL  
ASD--79

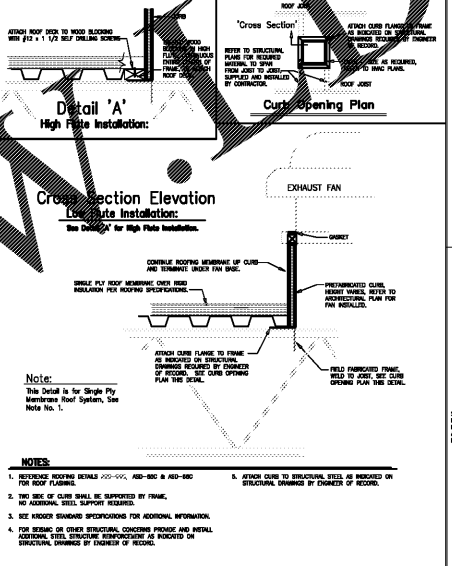

**PREFABRICATED FAN CURB**  
DATE: 11/10/16  
SCALE: NONE  
DRAWN: ZAW  
MASTER SPECIFICATION DETAIL  
ASD--88

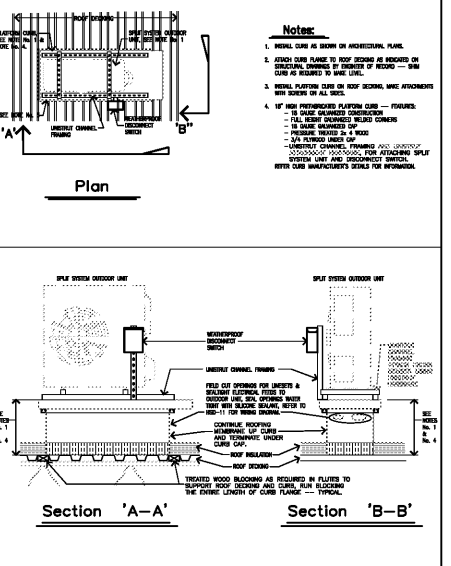

**PREFABRICATED NON-STRUCTURAL PLATFORM CURB**  
DATE: 2/13/17  
SCALE: NONE  
DRAWN: ZAW  
MASTER SPECIFICATION DETAIL  
ASD--89

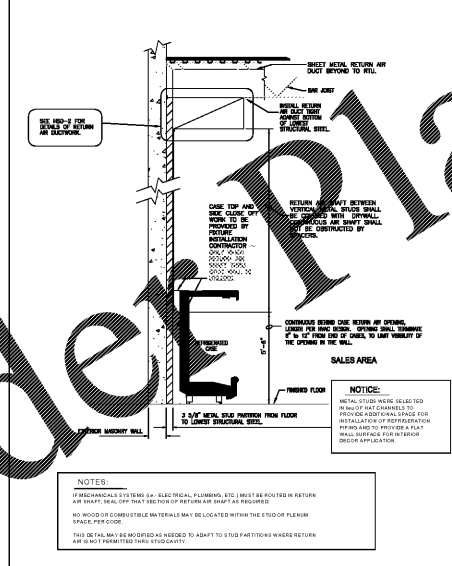

**RETURN AIR SHAFT FRAMING ON MASONRY WALL**  
DATE: 8/1/07  
SCALE: NONE  
DRAWN: ZAW  
MASTER SPECIFICATION DETAIL  
ASD--150M

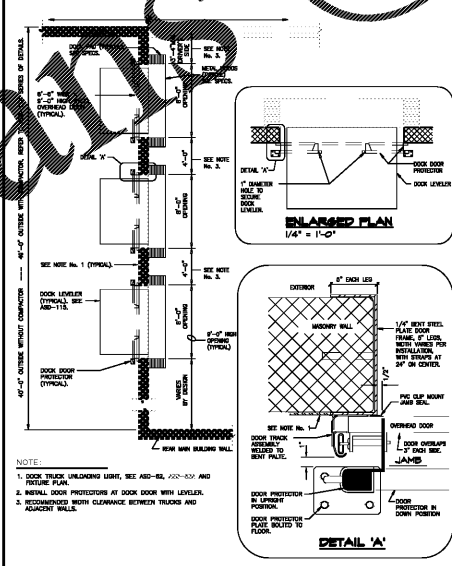

**DOCK DOORS INSTALLATION**  
DATE: 1/30/15  
SCALE: NONE  
DRAWN: ZAW  
MASTER SPECIFICATION DETAIL  
ASD--152

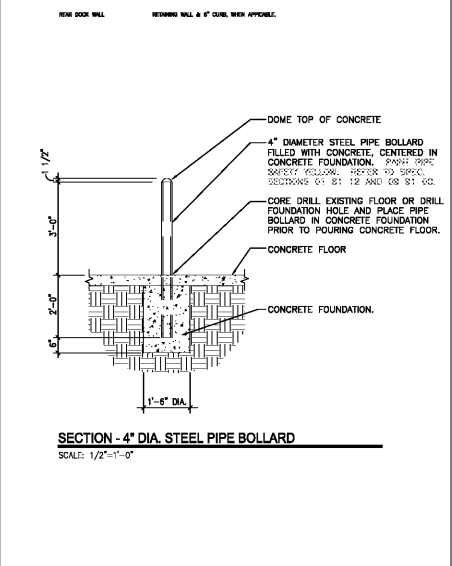

**INTERIOR STEEL BOLLARD DETAIL**  
DATE: 1/28/18  
SCALE: NONE  
DRAWN: ZAW  
MASTER SPECIFICATION DETAIL  
ASD--154A

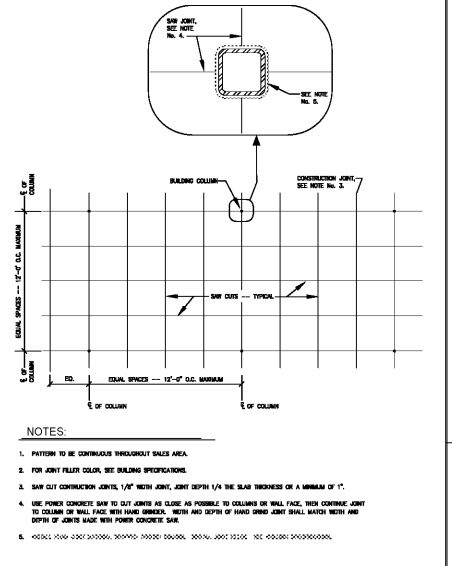

**CONCRETE PATTERN TYP. FOR POLISHED CONCRETE SALES AREA FLOORS**  
DATE: 11/21/14  
SCALE: NONE  
DRAWN: ZAW  
MASTER SPECIFICATION DETAIL  
ASD--156

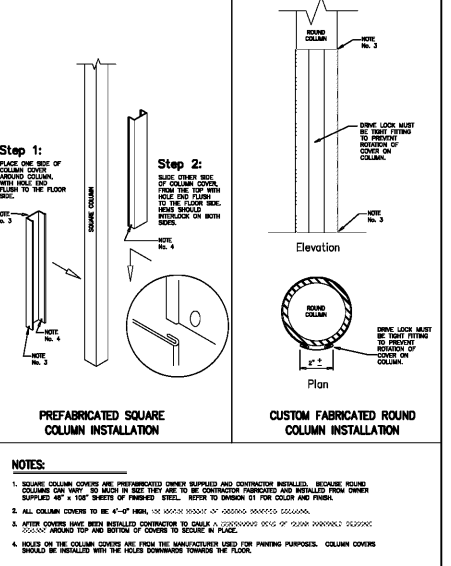

**PREFABRICATED SQUARE COLUMN INSTALLATION**  
DATE: 11/5/13  
SCALE: NONE  
DRAWN: ZAW  
MASTER SPECIFICATION DETAIL  
ASD--157

Order Plans

**THIS REPRODUCTION IS NOT A CERTIFIED DOCUMENT**



**Kroger L-407 - Remodel**  
3101 RICHMOND ROAD  
LEXINGTON, KY  
The Kroger Company  
1680 Ombaby Station Court, Louisville, KY 40223