

Order Plans

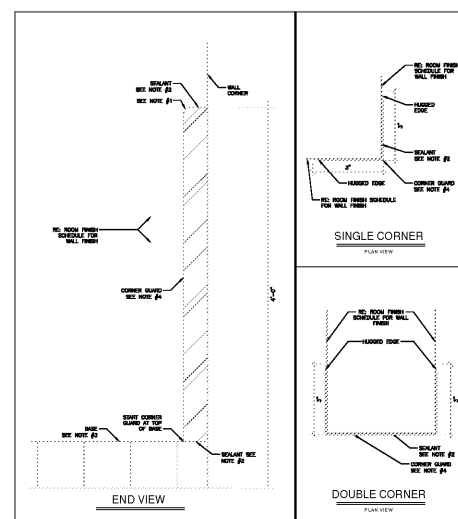

STAINLESS STEEL CORNER GUARD

DATE: 7/28/13
SCALE: NONE
DRAWN: TW

MASTER SPECIFICATION DETAIL ASD-55A

ORIGINAL ISSUE DATE: 7/28/13

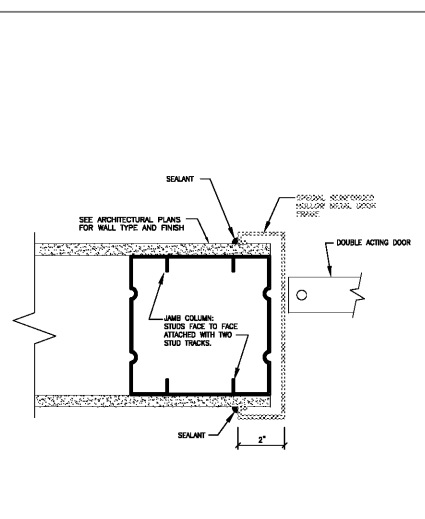

DOUBLE ACTING DOOR FRAME AT STUD PARTITION

DATE: 8/7/13
SCALE: NONE
DRAWN: ZAW

MASTER SPECIFICATION DETAIL ASD-56

ORIGINAL ISSUE DATE: 3/8/17

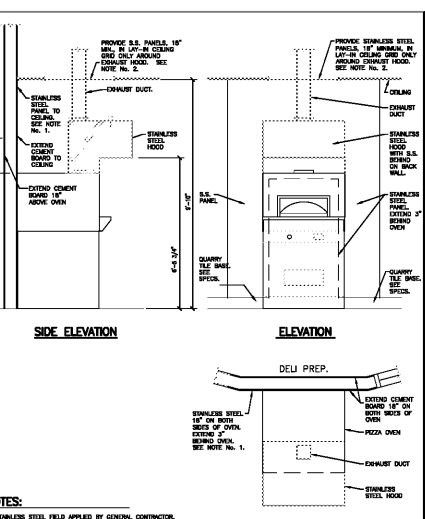

PIZZA OVEN STANDARD - S.S. FINISH

DATE: 3/8/17
SCALE: NONE
DRAWN: ZAW

MASTER SPECIFICATION DETAIL ASD-81

ORIGINAL ISSUE DATE: 3/8/17

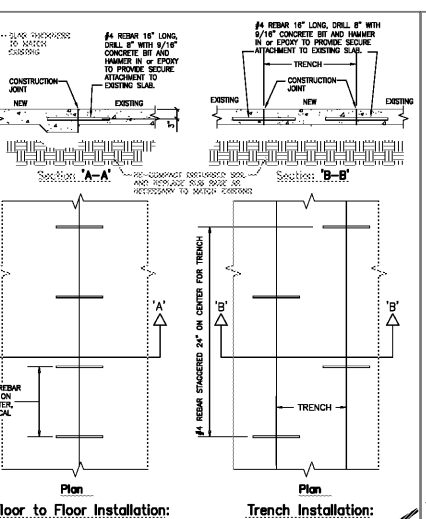

CONCRETE FLOOR REPLACEMENT AT EXISTING SLAB

DATE: 10/17/11
SCALE: NONE
DRAWN: TW

MASTER SPECIFICATION DETAIL ASD-89

ORIGINAL ISSUE DATE: 10/17/11

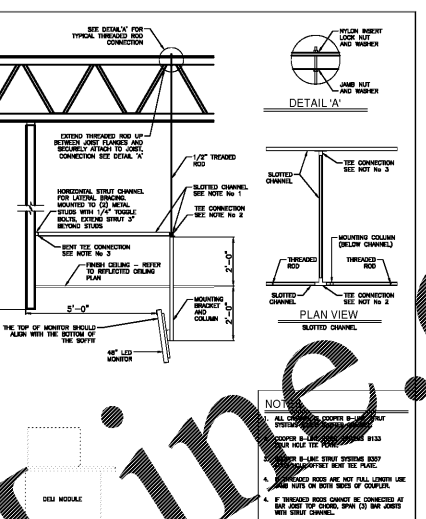

DELI MONITOR MOUNTING

DATE: 9/6/18
SCALE: NONE
DRAWN: TW

MASTER SPECIFICATION DETAIL ASD-72

ORIGINAL ISSUE DATE: 9/6/18

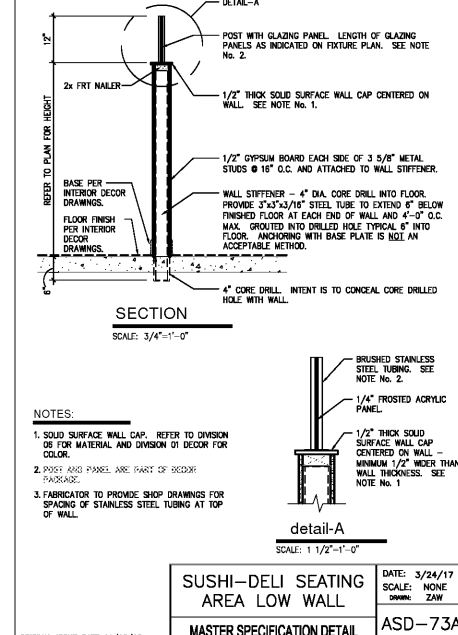

SUSHI-DELI SEATING AREA LOW WALL

DATE: 3/24/17
SCALE: NONE
DRAWN: ZAW

MASTER SPECIFICATION DETAIL ASD-73A

ORIGINAL ISSUE DATE: 11/10/18

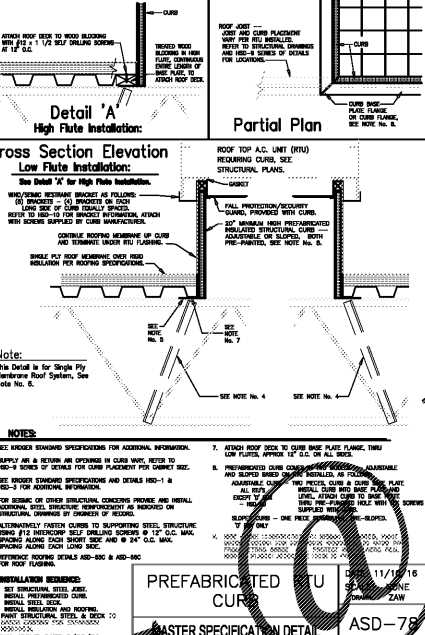

PREFABRICATED TU CURB

DATE: 11/10/18
SCALE: NONE
DRAWN: ZAW

MASTER SPECIFICATION DETAIL ASD-78

ORIGINAL ISSUE DATE: 2/22/20

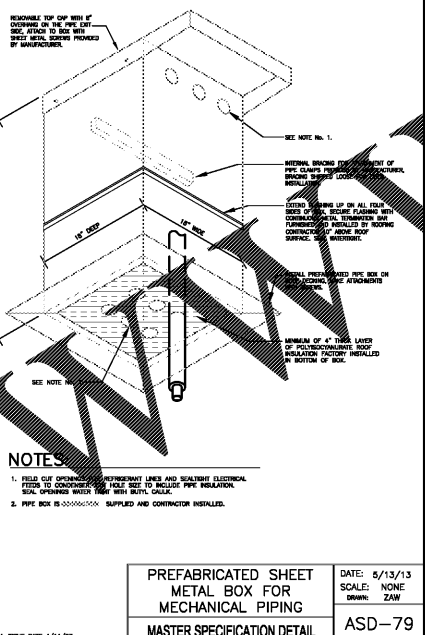

PREFABRICATED SHEET METAL BOX FOR MECHANICAL PIPING

DATE: 8/13/13
SCALE: NONE
DRAWN: ZAW

MASTER SPECIFICATION DETAIL ASD-79

ORIGINAL ISSUE DATE: 4/17/20

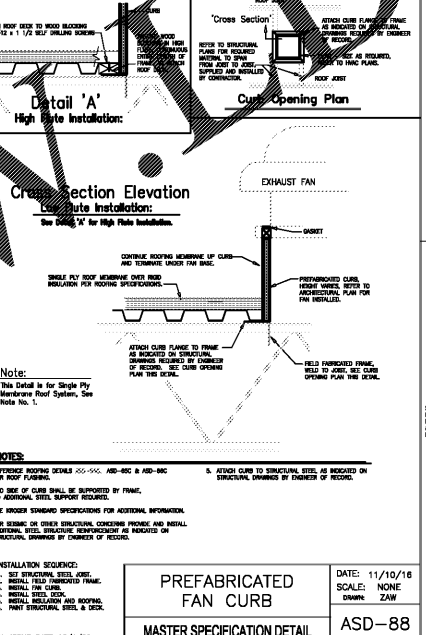

PREFABRICATED FAN CURB

DATE: 11/10/18
SCALE: NONE
DRAWN: ZAW

MASTER SPECIFICATION DETAIL ASD-88

ORIGINAL ISSUE DATE: 10/17/20

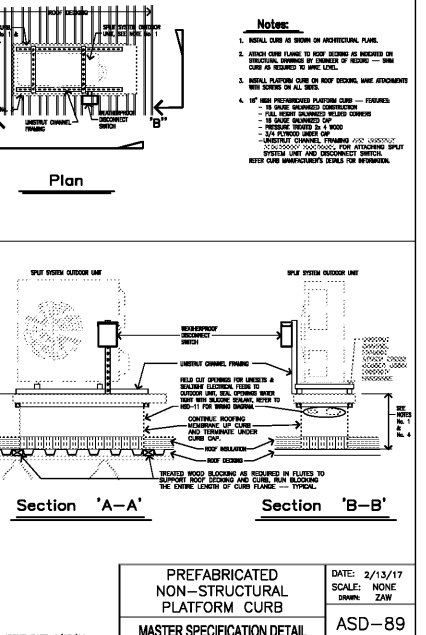

PREFABRICATED NON-STRUCTURAL PLATFORM CURB

DATE: 2/13/17
SCALE: NONE
DRAWN: ZAW

MASTER SPECIFICATION DETAIL ASD-89

ORIGINAL ISSUE DATE: 4/15/11

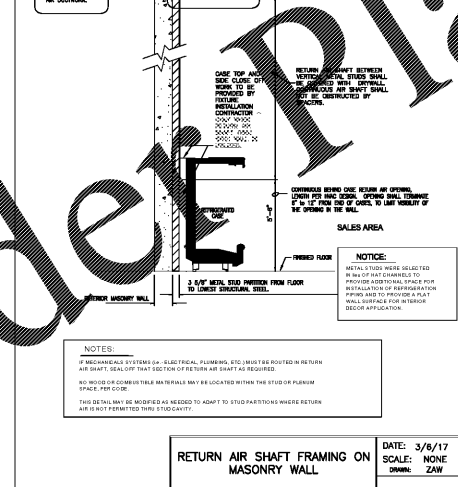

RETURN AIR SHAFT FRAMING ON MASONRY WALL

DATE: 8/17/07
SCALE: NONE
DRAWN: TW

MASTER SPECIFICATION DETAIL ASD-150M

ORIGINAL ISSUE DATE: 8/17/07

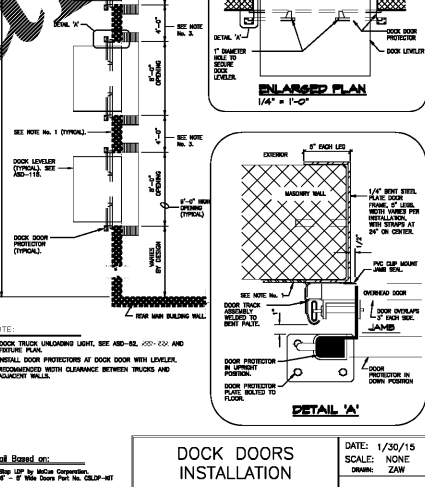

DOCK DOORS INSTALLATION

DATE: 1/30/15
SCALE: NONE
DRAWN: ZAW

MASTER SPECIFICATION DETAIL ASD-152

ORIGINAL ISSUE DATE: 2/22/20

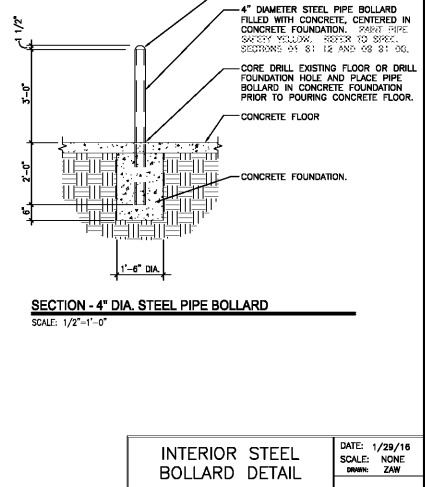

INTERIOR STEEL BOLLARD DETAIL

DATE: 1/28/16
SCALE: NONE
DRAWN: ZAW

MASTER SPECIFICATION DETAIL ASD-154A

ORIGINAL ISSUE DATE: 7/29/14

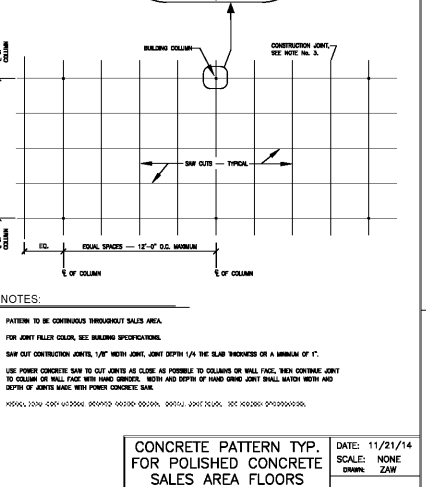

CONCRETE PATTERN TYP. FOR POLISHED CONCRETE SALES AREA FLOORS

DATE: 11/21/14
SCALE: NONE
DRAWN: ZAW

MASTER SPECIFICATION DETAIL ASD-156

ORIGINAL ISSUE DATE: 11/19/20

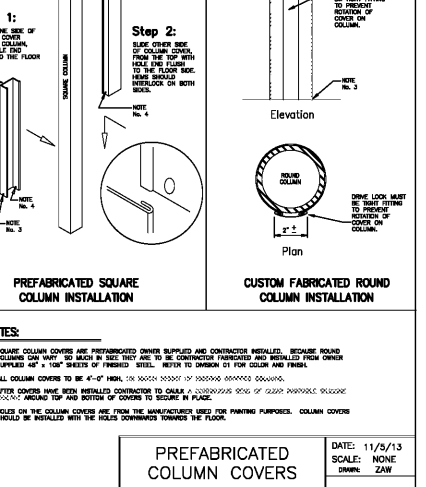

PREFABRICATED SQUARE COLUMN INSTALLATION

DATE: 11/9/13
SCALE: NONE
DRAWN: ZAW

MASTER SPECIFICATION DETAIL ASD-157

ORIGINAL ISSUE DATE: 11/19/20

ROBERTSON LOJA ROOF ARCHITECTS & ENGINEERS

3460 Preston Highway • Alpharetta, Georgia 30005
770-574-4477 • Fax: 770-574-9197-0745

THIS REPRODUCTION IS NOT A CERTIFIED DOCUMENT

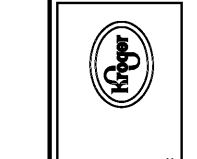

Kroger L-407 - Remodel
3101 RICHMOND ROAD
LEXINGTON, KY
The Kroger Company
1600 Ombaby Station Court, Louisville, KY 40223

REVISIONS

NO.	DESCRIPTION

ARCHITECTURAL STANDARD DETAILS (ASD)

DATE: 01-25-18
PROJECT NUMBER: 17-125
SHEET NUMBER: ASD.1.2

AS5.1.2