

1
E-601 NOT TO SCALE
DETAIL - TYPICAL DUPLEX RECEPTACLE INSTALLATION

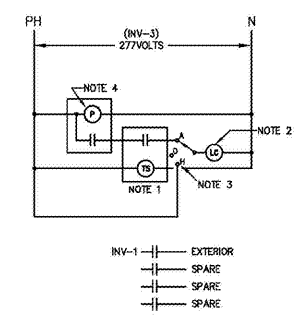

2
E-601 NOT TO SCALE
EXTERIOR LIGHTING CONTROL DIAGRAM - ELC

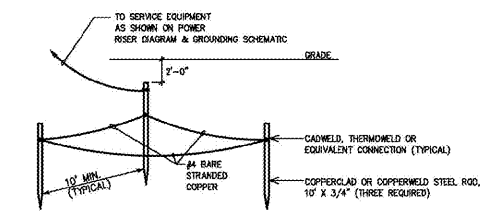

3
E-601 NOT TO SCALE
TYPICAL MADE GROUNDING ELECTRODE

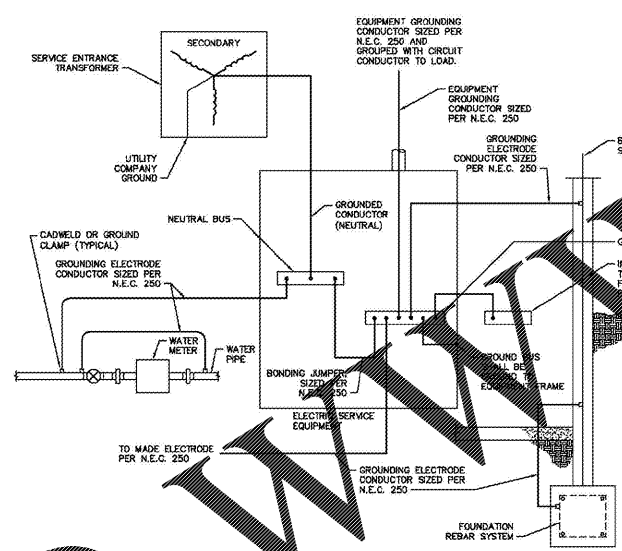

5
E-601 NOT TO SCALE
GROUNDING CONNECTION DIAGRAM

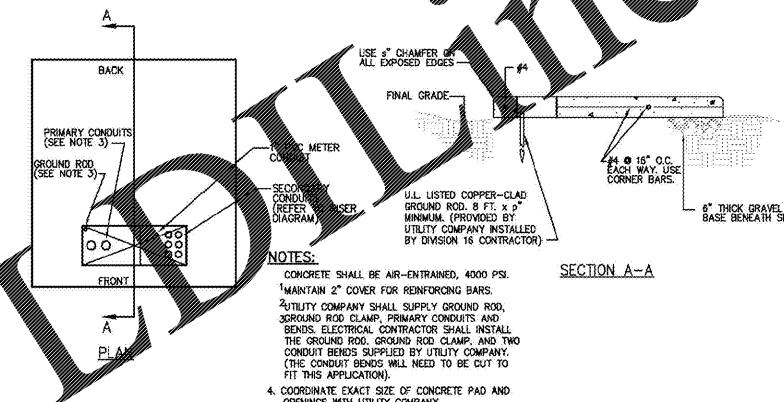

4
E-601 NOT TO SCALE
DETAIL - TRANSFORMER CONCRETE PAD

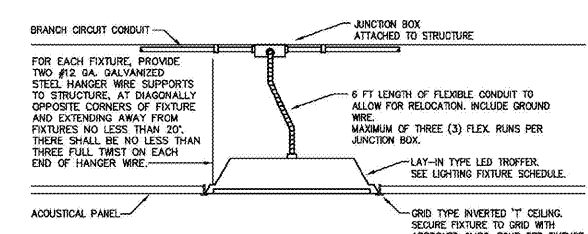

6
E-601 NOT TO SCALE
DETAIL - TYPICAL LAY-IN FIXTURE INSTALLATION

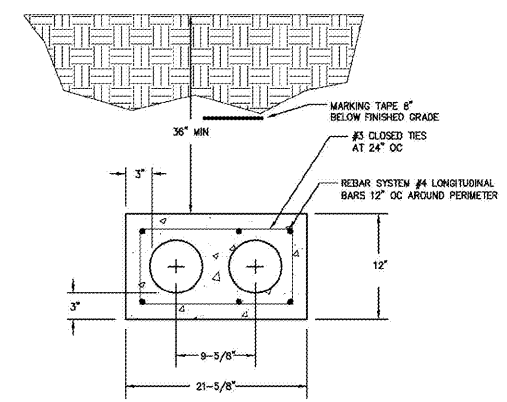

8
E-601 NOT TO SCALE
DETAIL - TELECOM SERVICE DUCTBANK

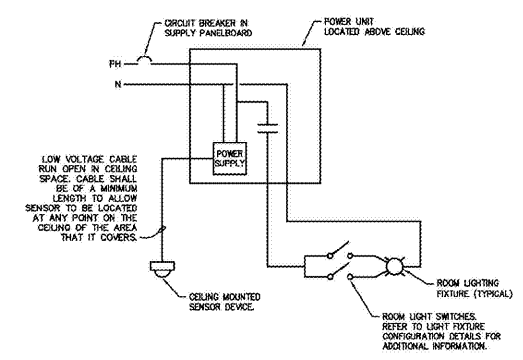

9
E-601 NOT TO SCALE
DETAIL - OCCUPANCY SENSOR CONTROL

WILKES COMMUNITY COLLEGE
WILKES COMMUNITY COLLEGE
SCO# 2016-01A
NBCS# 220
CULINARY LAB

McKNIGHT SMITH
WARD GRIFFIN
ENGINEERS, INCORPORATED
170 Box 245209 • 4223 South Boulevard
Charlotte, NC 28202
704/362-2112 17-083

LS3P

227 WEST TRADE STREET SUITE 700
CHARLOTTE, NORTH CAROLINA 28202
TEL. 704.333.8686 FAX 704.333.2926
WWW.LS3P.COM



MEMBERS OF THE AMERICAN INSTITUTE OF ARCHITECTS

COPYRIGHT 2016 ALL RIGHTS RESERVED
PRINTED OR ELECTRONIC DRAWINGS AND DOCUMENTATION MAY NOT BE REPRODUCED IN ANY FORM WITHOUT WRITTEN PERMISSION FROM LS3P ASSOCIATES LTD.

REVISIONS:

No.	Description	Date

PROJECT: 9202-169779
DATE: 12/18
DRAWN BY: SHW
CHECKED BY: MPA

DETAILS
E-601

C:\Users\kbrown\BROW\Documents\17413_WILKES CC CULINARY LAB_IBSWG_MP_2016_brown.rvt
1/2/2018 1:56:06 PM

Order Plans