

6 HEAD
1 1/2" x 1'-0"

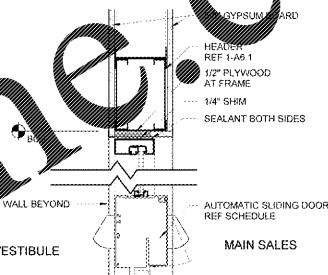

5 HEAD
1 1/2" x 1'-0"

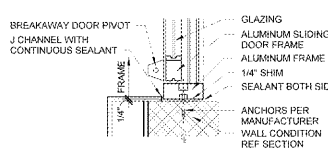

4A JAMB
1 1/2" x 1'-0"

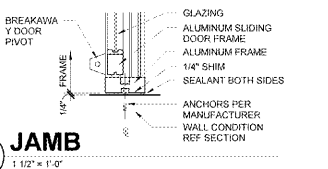

4 JAMB
1 1/2" x 1'-0"

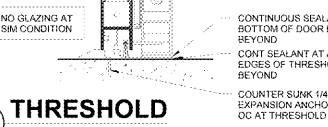

3 THRESHOLD
5" x 1'-0"

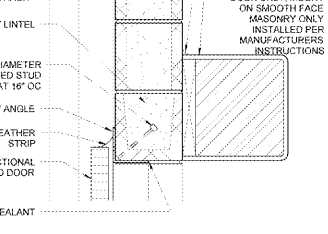

2 HEAD
1 1/2" x 1'-0"

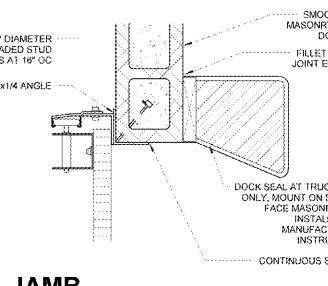

1 JAMB
1 1/2" x 1'-0"

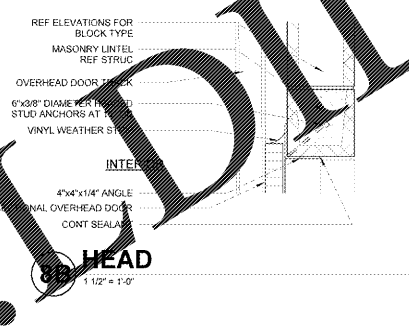

8B HEAD
1 1/2" x 1'-0"

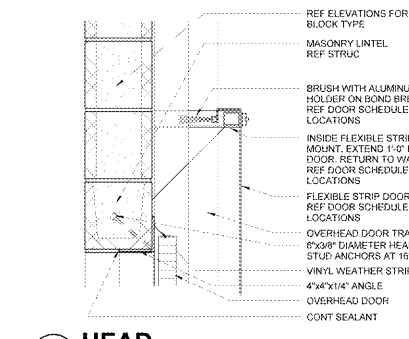

8A HEAD
1 1/2" x 1'-0"

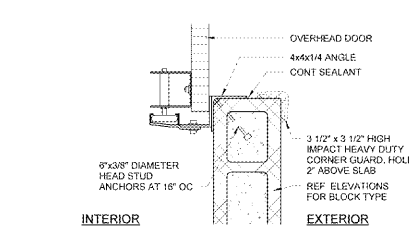

7B JAMB
1 1/2" x 1'-0"

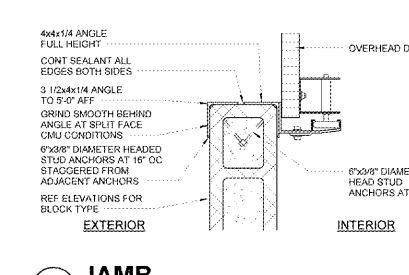

7A JAMB
1 1/2" x 1'-0"

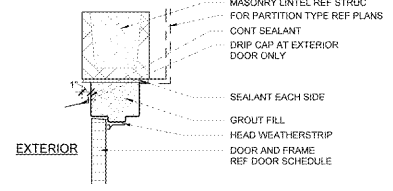

15 HEAD
1 1/2" x 1'-0"

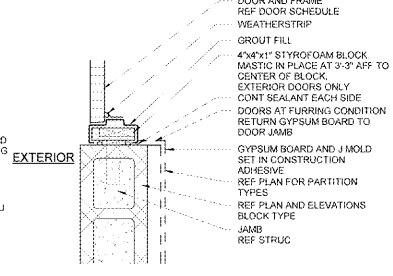

14 JAMB
1 1/2" x 1'-0"

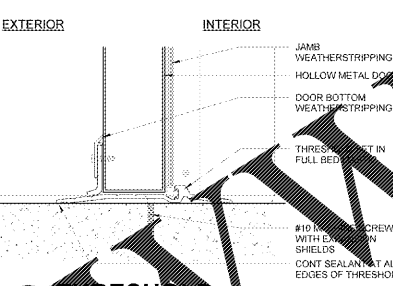

13 THRESHOLD
2" x 1'-0"

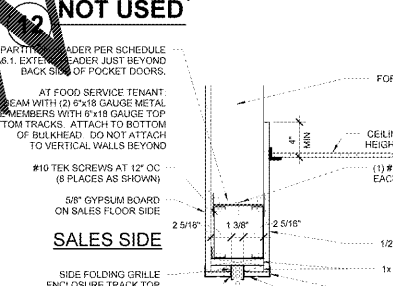

12 NOT USED

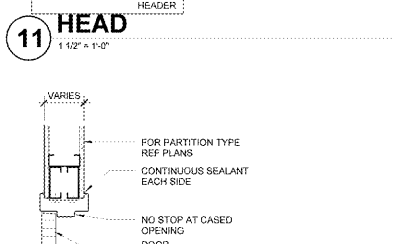

11 HEAD
1 1/2" x 1'-0"

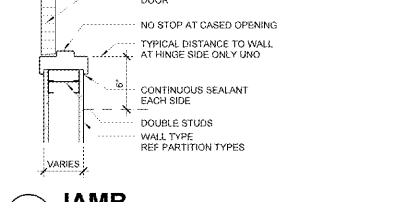

10 HEAD
1 1/2" x 1'-0"

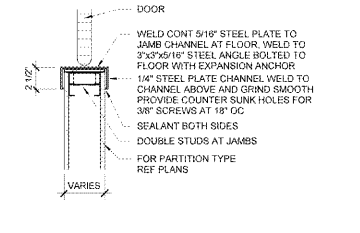

20 JAMB
1 1/2" x 1'-0"

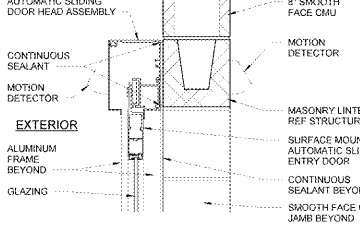

19B HEAD
1 1/2" x 1'-0"

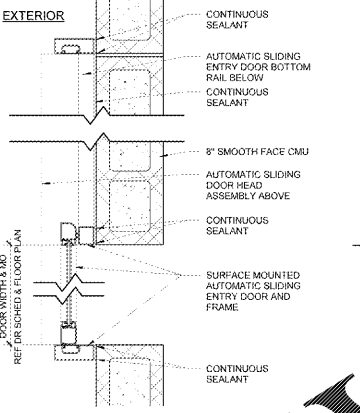

19A JAMB
1 1/2" x 1'-0"

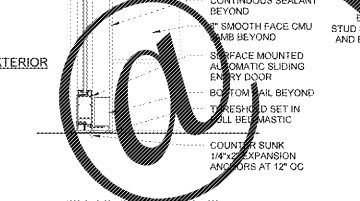

18 THRESHOLD
1 1/2" x 1'-0"

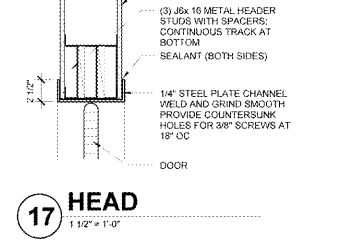

17 HEAD
1 1/2" x 1'-0"

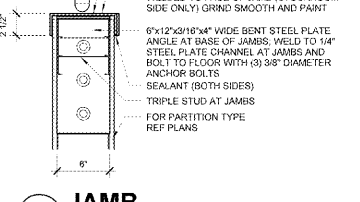

16 JAMB
1 1/2" x 1'-0"



25 JAMB
1 1/2" x 1'-0"

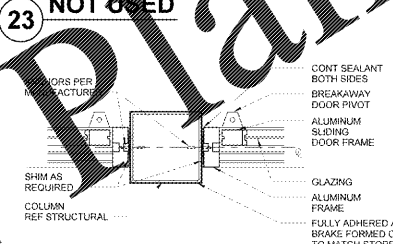

24 THRESHOLD
1 1/2" x 1'-0"

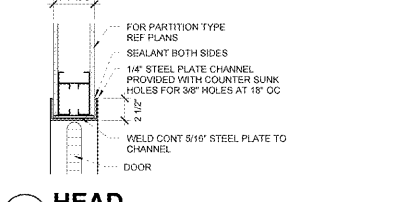

23 NOT USED

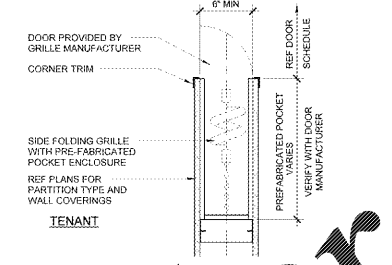

27 JAMB
1 1/2" x 1'-0"

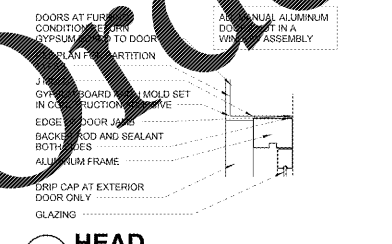

26 HEAD
1 1/2" x 1'-0"

Order Plans @ WWW.IDOLine.com