

TABLE MU-1 MULCHING MATERIALS AND APPLICATION RATES

MATERIAL	RATE PER ACRE (PER 1000 SQ.FT.)	NOTES
STRAW WITH SEED	1.92 - 2 TONS (110 LBS - 90 LBS)	SPREAD BY HAND OR MACHINE TO OBTAIN 75% GROUND COVER, ANCHOR WHEN SUBJECT TO BLOWING.
STRAW ALONE (NO SEED)	2.92 - 3 TONS (170 LBS - 160 LBS)	SPREAD BY HAND OR MACHINE, ANCHOR WHEN SUBJECT TO BLOWING.
WOOD CHIPS	5.4 TONS (250 LBS - 270 LBS)	TREAT WITH 12 LBS NITROGEN/TON.
BARK	35 CUBIC YARDS (8 CUBIC YARD)	CAN APPLY WITH MULCH BLOWER.
FINE STRAW	1.3 TON (60 LBS - 90 LBS)	SPREAD BY HAND OR MACHINE, WILL NOT HOLD LIKE STRAW.
PEANUT HULLS	10-20 TON (60 LBS - 90 LBS)	WILL WASH OFF SLOPE WITH 12 LBS NITROGEN/TON.

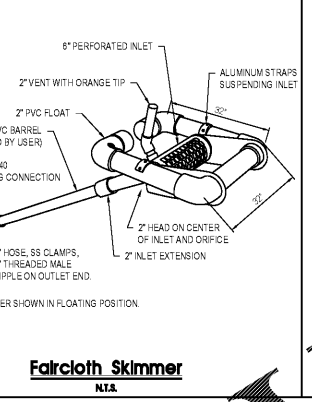
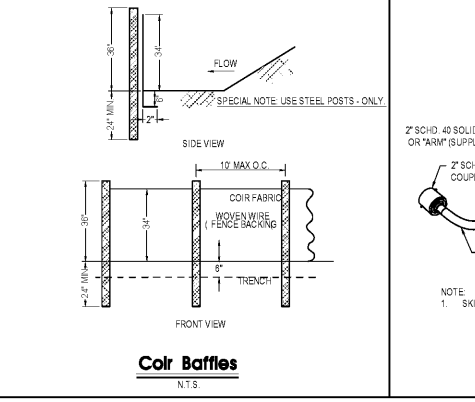
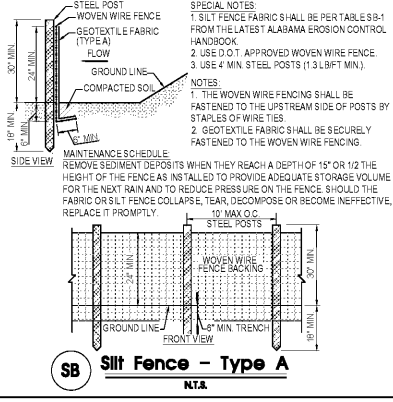
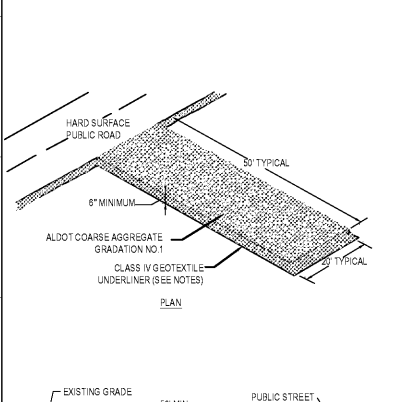

TABLE TS-1 COMMONLY USED PLANTS FOR TEMPORARY COVER

SPECIES	SEEDING RATE PER AC P.L.B.	NORTH	CENTRAL	SOUTH
MILLET, BIRDSEED	40 LBS	APR 1 - JULY 15	APR 1 - JULY 15	APR 1 - JULY 15
RYE	30 LBS	SEPT 15 - NOV 15	SEPT 15 - NOV 15	SEPT 15 - NOV 15
GRASS	10 LBS	AUG 15 - SEPT 15	SEPT 15 - OCT 15	OCT 15 - NOV 15
ST. AUGUSTINE GRASS	40 LBS	MAY 15 - AUG 15	APR 15 - JULY 15	APR 15 - JULY 15
SUNDOG	40 LBS	MAY 15 - AUG 15	APR 15 - JULY 15	APR 15 - JULY 15
WHEAT	30 LBS	SEPT 15 - NOV 15	SEPT 15 - NOV 15	SEPT 15 - NOV 15
COMMON BERMUDAGRASS	10 LBS	APR 15 - JULY 15	APR 15 - JULY 15	APR 15 - JULY 15
CRIMSON CLOVER	10 LBS	SEPT 15 - NOV 15	SEPT 15 - NOV 15	SEPT 15 - NOV 15

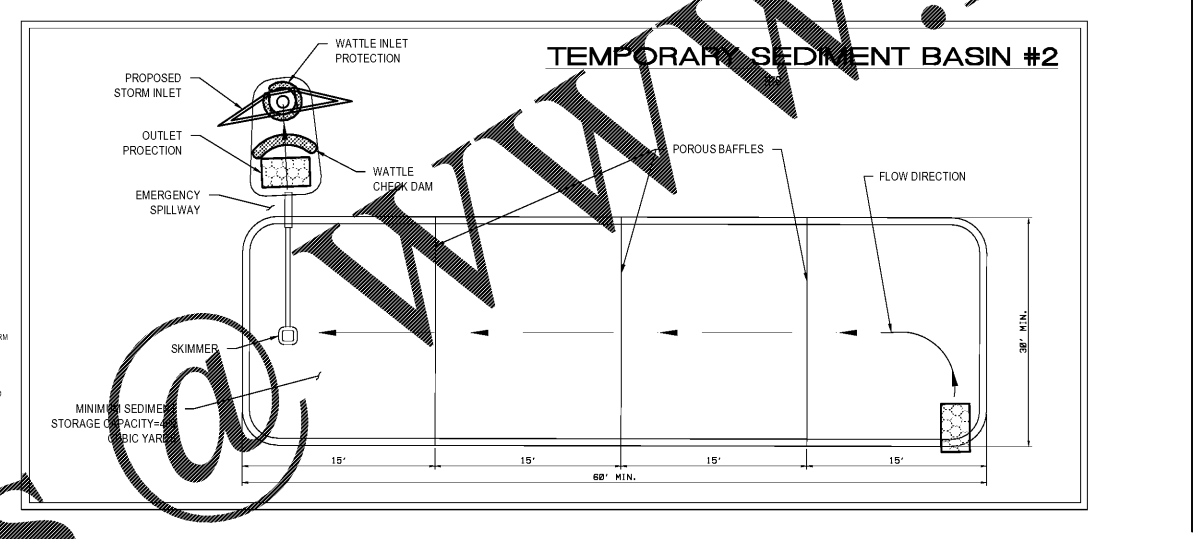
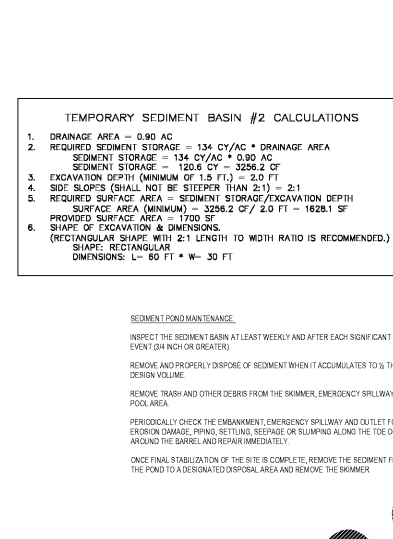
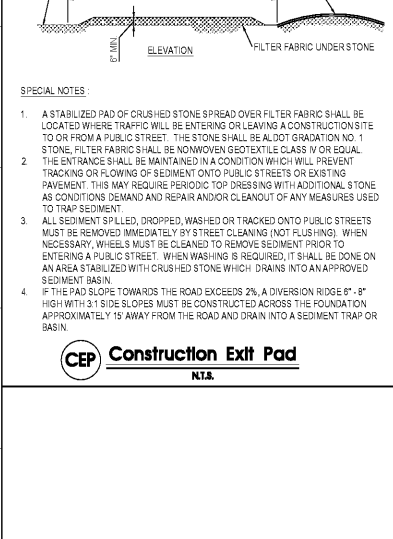

TABLE PS-1 COMMONLY USED PLANTS FOR PERMANENT COVER WITH SEEDING RATES AND DATES

SPECIES	SEEDING RATE PER AC P.L.B.	NORTH	CENTRAL	SOUTH
SAHAGRASS, PENNSYLVANIA	40 LBS	APR 1 - JULY 15	APR 1 - JULY 15	APR 1 - JULY 15
BERMUDAGRASS, COMMON	10 LBS	APR 1 - JULY 15	MAR 15 - JULY 15	MAR 15 - JULY 15
SAHAGRASS, PENNSYLVANIA	30 LBS	APR 1 - JULY 15	MAR 15 - JULY 15	MAR 15 - JULY 15
BERMUDAGRASS, COMMON	20 LBS	APR 1 - JULY 15	MAR 15 - JULY 15	MAR 15 - JULY 15
BERMUDAGRASS, HYBRID (LAWN TYPES)	SOLID SOG	ANYTIME	ANYTIME	ANYTIME
BERMUDAGRASS, HYBRID (LAWN TYPES)	SPRIGS	MAR 1 - AUG 15	MAR 1 - JULY 15	FEB 15 - SEPT 1
FESCUE, TALL	40-50 LBS	SEPT 1 - NOV 15	SEPT 1 - NOV 15	SEPT 1 - NOV 15
SERICEA	40-60 LBS	MAR 15 - JULY 15	MAR 15 - JULY 15	FEB 15 - JULY 15
SERICEA, COMMON	40-60 LBS	MAR 15 - JULY 15	MAR 15 - JULY 15	FEB 15 - JULY 15
SMITHGRASS, ALAMO	40 LBS	APR 1 - JUN 15	MAR 15 - JUN 15	MAR 15 - JUN 15

PLS MEANS PURE LIVE SEED AND IS USED TO ADJUST SEEDING RATES. FOR EXAMPLE: 10 PLANT 10 LBS PLS OF A SPECIES WITH GERMINATION OF 80% AND 10% NEET MATERIAL = 10 LBS / 0.70 = 14.3 LBS.

Mulching, Temporary Seeding, & Permanent Seeding Directions
NTA

1. ANY DISTURBED AREA SHALL, WITHIN FOURTEEN (14) DAYS OF STOPPING WORK, BE PLANTED OR OTHERWISE PROVIDED WITH GROUND COVER, MATERIALS, DEVICES, AND/OR STRUCTURES SUFFICIENT TO RESTRAIN ALL FORMS OF EROSION, TO THE MAXIMUM EXTENT PRACTICABLE.
2. CONTRACTOR TO COORDINATE PERMANENT SEEDING WITH OWNER.

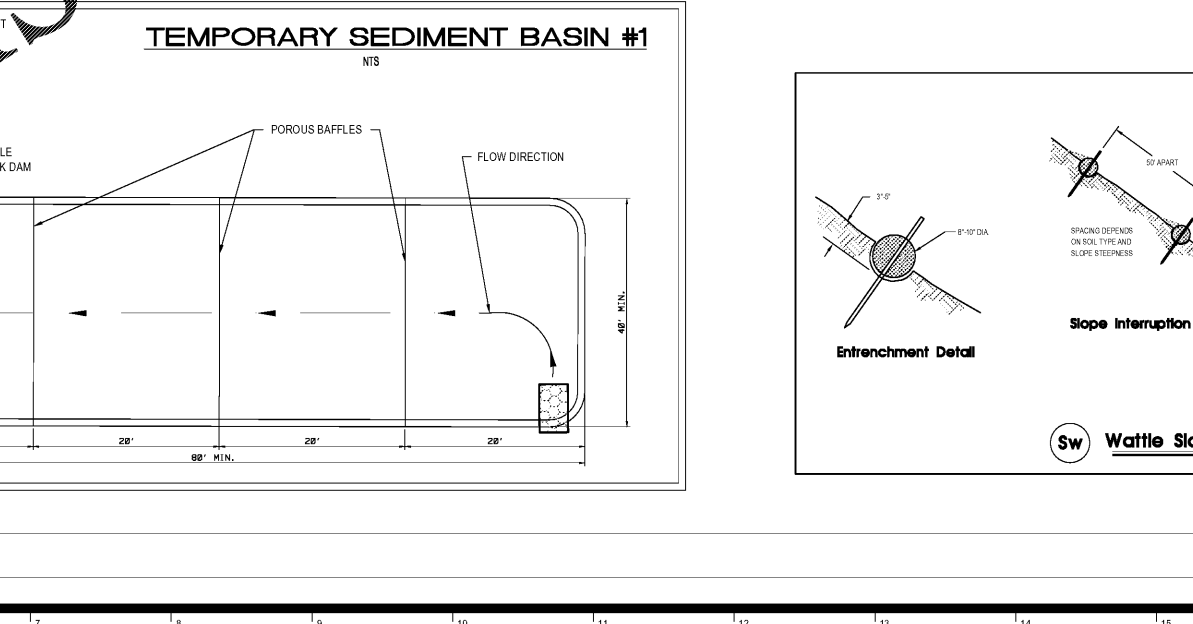
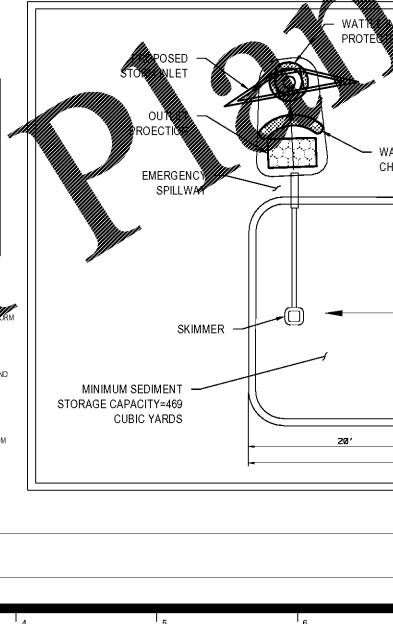
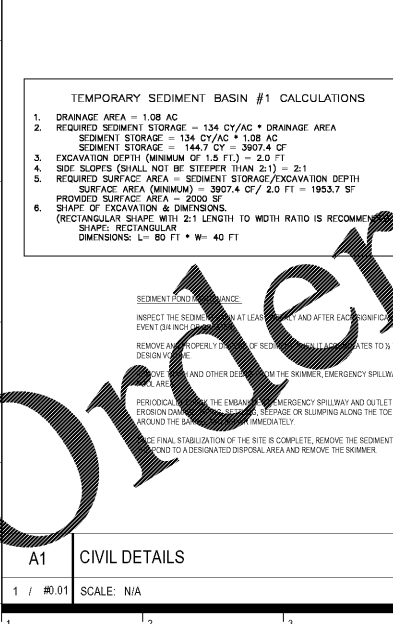

CIVIL DETAILS
NTA

DATE: OCTOBER 08, 2017

PROJECT NO.: 100% CONSTRUCTION DOCUMENTS

PROJECT NO.: 3822

DESIGNED BY: DAVIS ARCHITECTS

CHECKED BY: DAVIS ARCHITECTS

DRAWING NO.: C6.0

Order Plans

A1 CIVIL DETAILS
1 / 01 SCALE: N/A

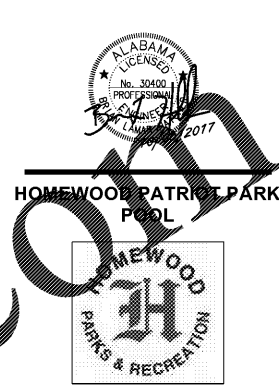

HOMEWOOD PARKS AND RECREATION; HOMEWOOD, AL

OWNER: HOMEWOOD PARKS AND RECREATION
1632 OXNOR ROAD
HOMEWOOD, AL 35209
205-324-2704
ATTN: BERLEY SQUIRES

ARCHITECT: DAVIS ARCHITECTS, INC.
120 23RD STREET SOUTH
BIRMINGHAM, AL 35233
205-322-7482
ATTN: JIM HARTSELL

LANDSCAPE ARCHITECT: HNP
1914 28TH AVE S.
BIRMINGHAM, AL 35209
205-324-4447
ATTN: TOMMY HOLCOMBE / ED NORTON

CONSTRUCTION MANAGER: BL HARBERT
820 SHADES CREEK PARKWAY, SUITE 3000
BIRMINGHAM, AL 35209
205-802-2800
ATTN: JOHN HANSON

STRUCTURAL ENGINEER: LBYD INC.
716 SOUTH 30TH STREET
BIRMINGHAM, AL 35233
205-351-4600
ATTN: WIN BISHOP / BRAD CHRISTOPHER

MECHANICAL ENGINEER: WHITAKER & RAWSON
3332 OLD MONTGOMERY HIGHWAY
SUITE 103
BIRMINGHAM, AL 35209
205-870-8001
ATTN: DAN WHITAKER, ERIC HARTWIG, AND MARK D'ANDREA

CIVIL ENGINEER: LBYD INC.
716 SOUTH 30TH STREET
BIRMINGHAM, AL 35233
205-351-4600
ATTN: CURTIS EATMAN AND BRIAN HATCHER

ELECTRICAL ENGINEER: FISHER ARNOLD
1507 ALEX DR.
SUITE 101
BIRMINGHAM, AL 35210
205-853-7033
ATTN: JOSEPH KUMU AND NICHOLAS BROWN

PLUMBING / FIRE PROTECTION ENGINEER: EDMONDS ENGINEERING
2 RIVERCHASE OFFICE PLAZA
SUITE 205
BIRMINGHAM, AL 35244
205-988-2069
ATTN: CAROL JOHNSON

POOL CONSULTANT: COUNSLMAN HUNSAKE
10733 SUNSET OFFICE DRIVE
SUITE 400
ST. LOUIS, MO 63127
314-894-1245
ATTN: JEFF WOODRFT