

ALL DESIGNS, DRAWINGS AND SPECIFICATIONS DEPICTED ON THIS SHEET ARE THE PROPERTY OF RIV ARCHITECTURE, P.A. ANY UNAUTHORIZED USE OR REPRODUCTION IS SUBJECT TO LEGAL PROSECUTION. POSSESSION IN ANY FORM CONSTITUTES ACCEPTANCE OF THESE CONDITIONS. COPYRIGHT 2017



Project
Sam's Mart
E. Independence Blvd.
Indian Trail, NC 28097

Owner
Sam's Mart

ENGINEERING
2923 South Tryon Street, Suite 280
Charlotte, North Carolina 28203
tel 704.373.0068

MECHANICAL ELECTRICAL
28203 Council Place, Suite 200
Matthews, NC 28105



FIRM NUMBER = C-2130

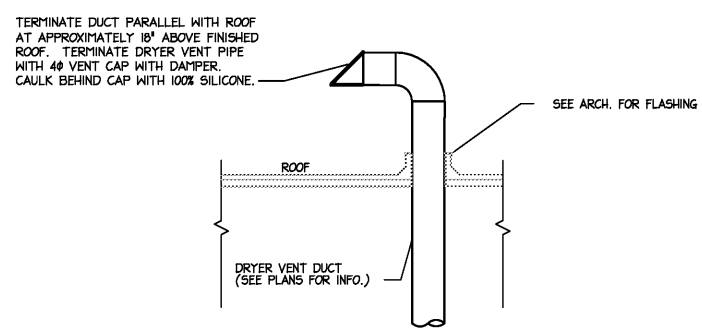

1 DRYER VENT ROOF PENETRATION
NO SCALE

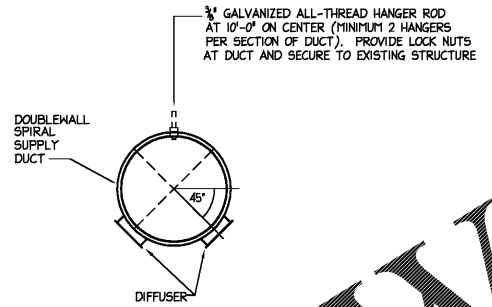

- NOTES:**
- DUCTWORK SHALL BE INSTALLED LEVEL.
 - SUPPLY DUCTWORK SHALL BE SPIRAL DUCTWORK WITH A PAINT GRIP FINISH.

2 SPIRAL DUCT DETAIL
NO SCALE

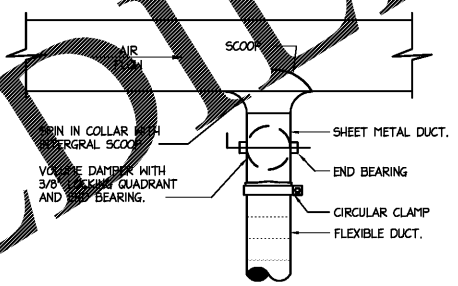

- NOTES:**
- SEE FLOOR PLANS AND SPECIFICATIONS FOR DUCT INSULATION REQUIREMENTS.
 - TAP OFF TOP/SIDE/BOTTOM OF DUCT AS REQUIRED

3 BRANCH TAKEOFF TO SINGLE OUTLET
NO SCALE

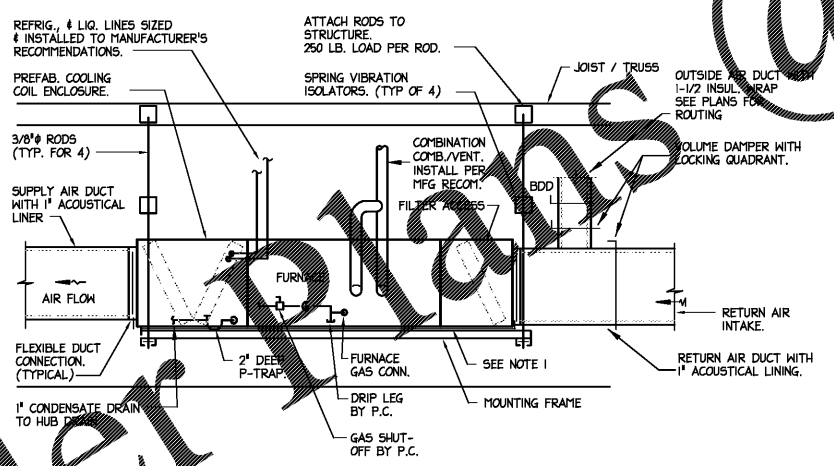

- NOTES:**
- SECONDARY DRAIN PAN WITH MICROFLOAT SWITCH, INTERLOCK FLOAT SWITCH W/ FURNACE. INSTALL FLOAT SWITCH IN ONE CORNER OF PAN AND TILT PAN TO THAT CORNER.

4 FURNACE DETAIL
NO SCALE

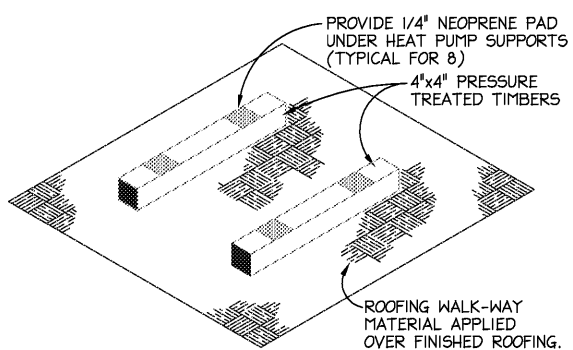

- NOTE:**
- ALL HEAT PUMP UNITS LOCATED ON THE ROOF SHALL BE MOUNTED AS SHOWN.
 - ALL HEAT PUMP UNITS TO BE EQUIPPED WITH VIBRATION ISOLATORS.

5 HEAT PUMP UNIT ROOF MOUNTING DETAIL
NO SCALE

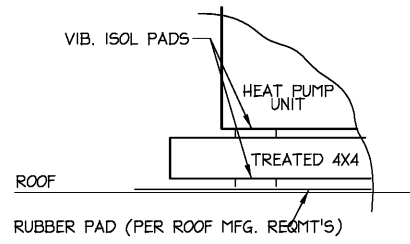

6 CONDENSING UNIT PAD DETAIL
NO SCALE

RIV
ARCHITECTURE, P.A.

124 Floyd Smith Dr
Suite 375
Charlotte, NC 28262
Tel - 704 - 688-7500

7301 Rivers Avenue
Suite 188
North Charleston, SC 29406
Tel - 843 - 531-6848

www.R4architecture.com

Revision	Date

Drawn By Saber
Checked By Saber
Issue Date 07-05-17
Project No 160345

Sheet Title
MECHANICAL
DETAILS

Sheet Number
M301

Order Plans