

11 WATER FILTRATION DETAIL
P300 N.T.S.

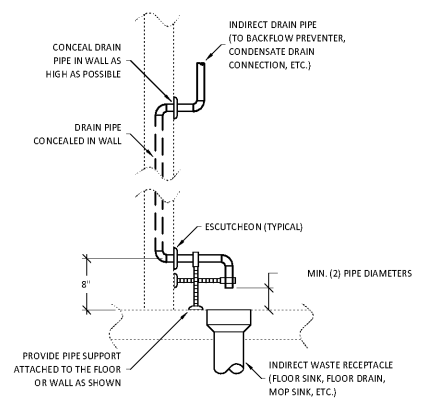

10 INDIRECT WASTE PIPING DETAIL
P300 N.T.S.

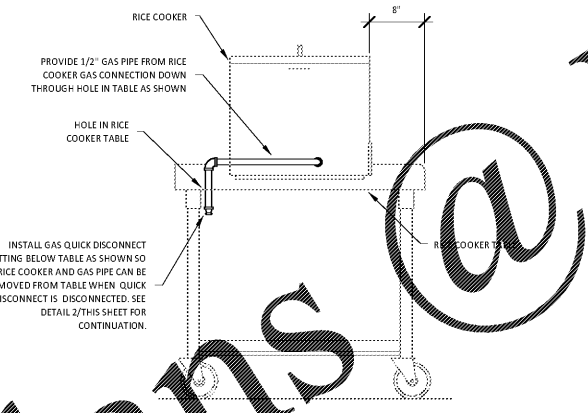

12 RICE COOKER GAS CONNECTION DETAIL
P300 N.T.S.

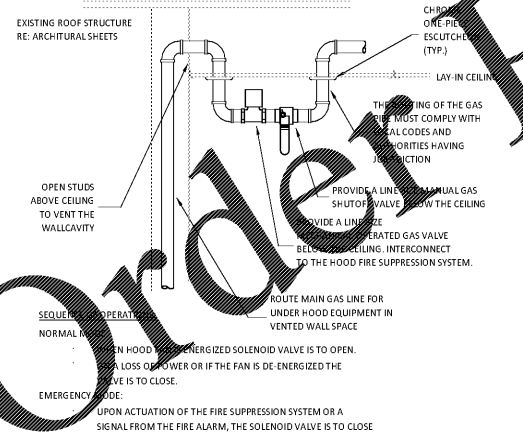

12 KITCHEN GAS SHUTOFF DETAIL
P300 N.T.S.

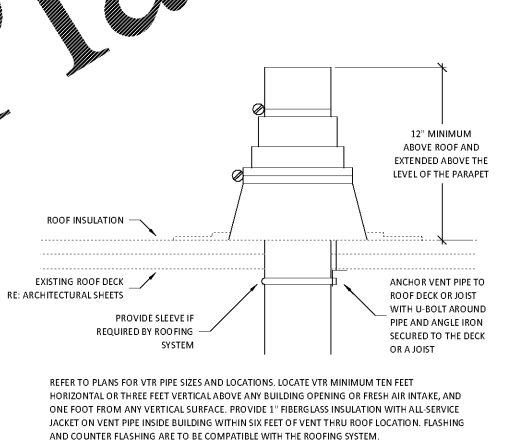

8 VENT THROUGH ROOF
P300 N.T.S.

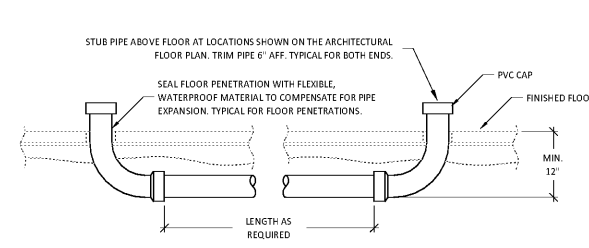

7 SODA CONDUIT DETAIL
P300 N.T.S.

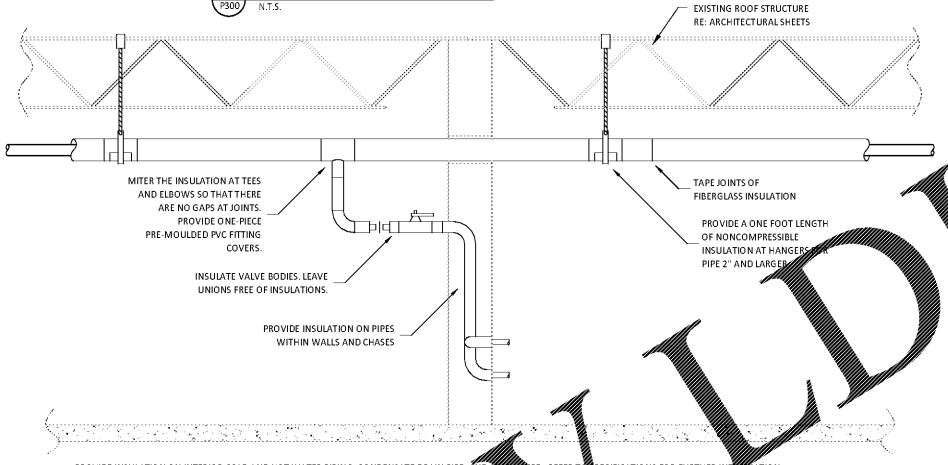

6 PIPE INSULATION DETAIL
P300 N.T.S.

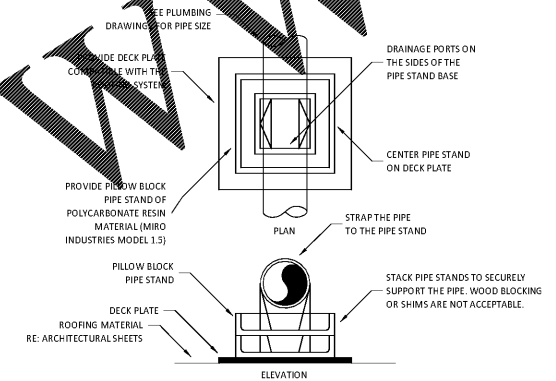

5 ROOFTOP PIPING SUPPORT
P300 N.T.S.

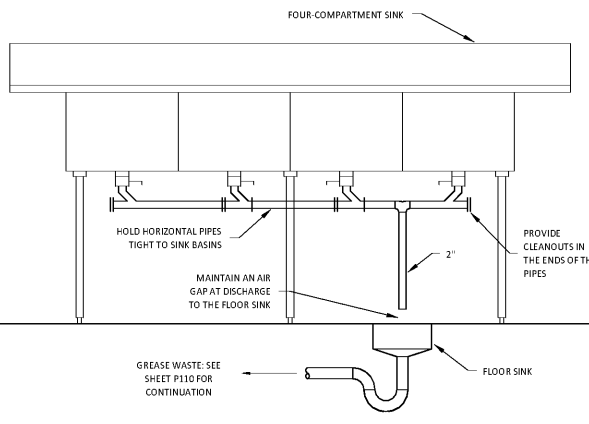

4 WARE-WASHING SINK DETAIL
P300 N.T.S.

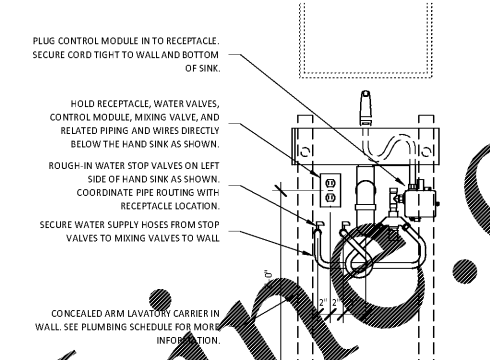

3 RESTROOM HAND SINK DETAIL
P300 N.T.S.

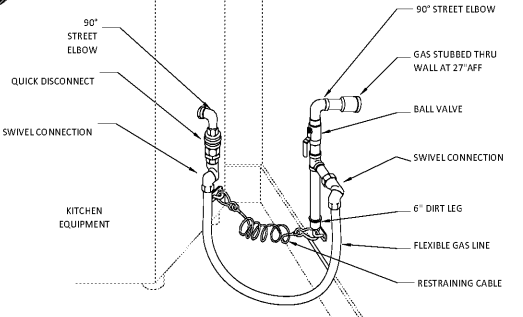

2 KITCHEN GAS EQUIPMENT DETAIL
P300 N.T.S.

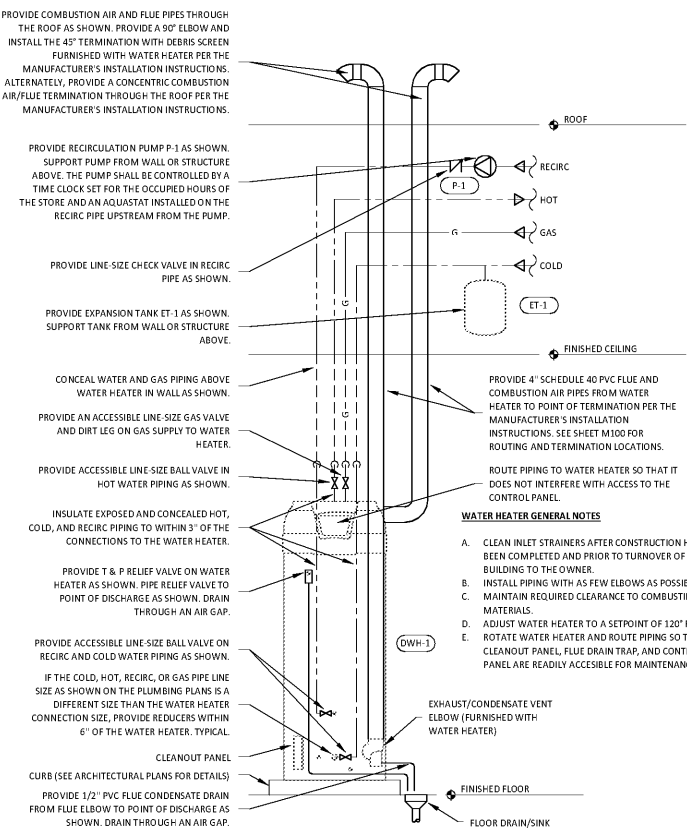

1 WATER HEATER DETAIL
P300 N.T.S.

NATIONAL ENGINEERING
7880 Madison Road
Columbus, Ohio 43230
Phone: (614) 751-9610
Fax: (614) 552-5240
Contact: Mike Chapman
(614) 595-9543
mchapman@nationalengineering.com

COPYRIGHT 2017
THIS DRAWING IS AN INSTRUMENT OF SERVICE AND AS SUCH
REMAINS THE PROPERTY OF CHIPOTLE MEXICAN GRILL, INC.
PERMISSION FOR USE OF THIS DOCUMENT IS LIMITED AND
CAN BE EXTENDED ONLY BY WRITTEN AGREEMENT WITH
CHIPOTLE MEXICAN GRILL, INC.



STORE NO.: 3007
PURCELLVILLE
Berlin Turnpike and West Colonial
Highway
Purcellville, VA 20132

Issue Number:	12.19.2016	Permit Set
Drawn:		Checked:
Project No.:	1601065	RTJ

PLUMBING DETAILS

P300
Date of Last Print: 12.19.2016