

1 Framing Plan
SCALE: 3/4" = 1'-0"

2 Framing Detail
SCALE: 3/4" = 1'-0"

3 Framing Detail
SCALE: 3/4" = 1'-0"

4 Framing Detail
SCALE: 3/4" = 1'-0"

5 Framing Detail
SCALE: 3/4" = 1'-0"

6 Framing Detail
SCALE: 3/4" = 1'-0"

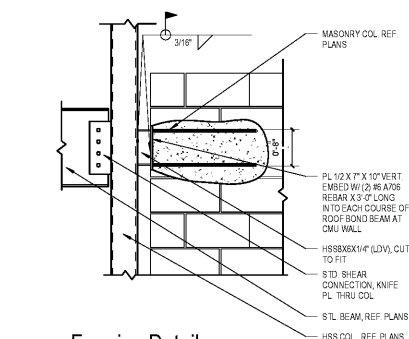

7 Framing Detail
SCALE: 3/4" = 1'-0"

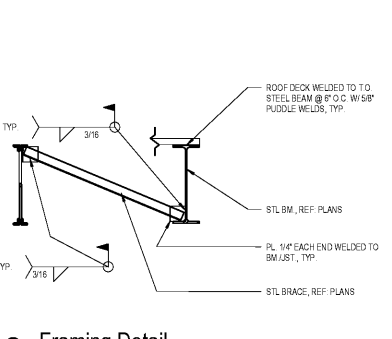

8 Framing Detail
SCALE: 3/4" = 1'-0"

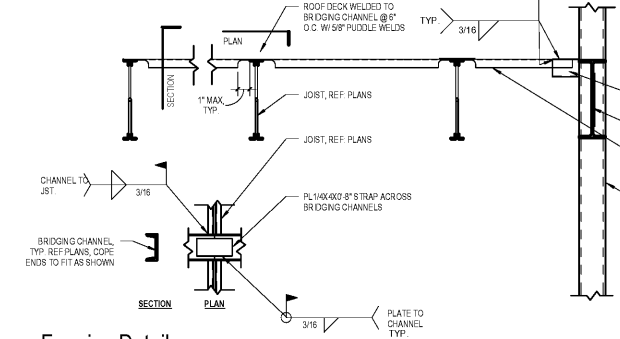

9 Framing Detail
SCALE: 3/4" = 1'-0"

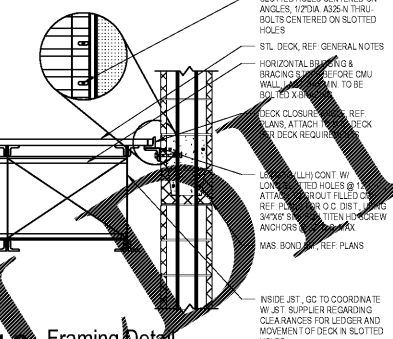

10 Framing Detail
SCALE: 3/4" = 1'-0"

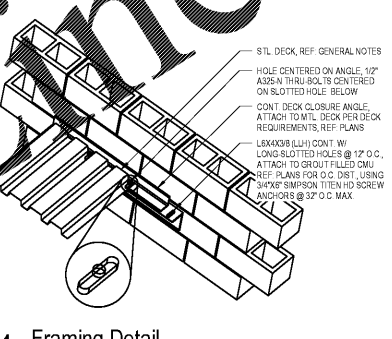

11 Framing Detail
SCALE: 3/4" = 1'-0"

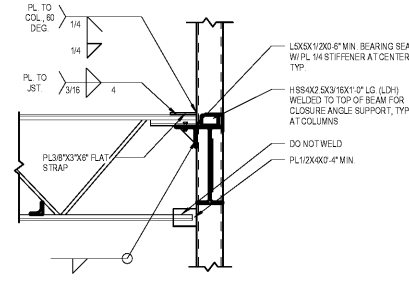

12 Framing Detail
SCALE: 3/4" = 1'-0"

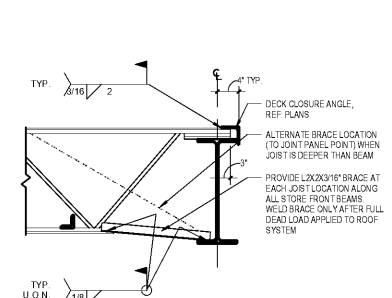

13 Framing Detail
SCALE: 3/4" = 1'-0"

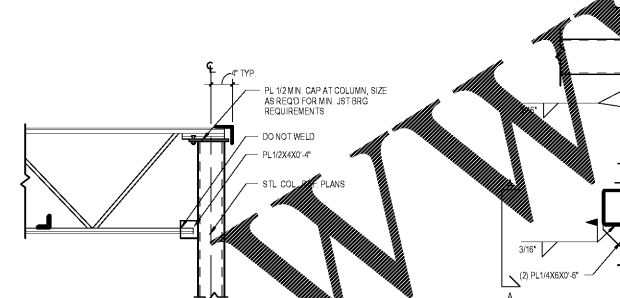

14 Framing Detail
SCALE: 3/4" = 1'-0"

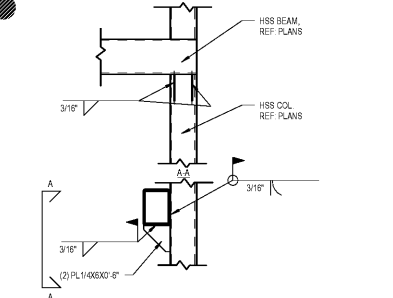

15 Framing Detail
SCALE: 3/4" = 1'-0"

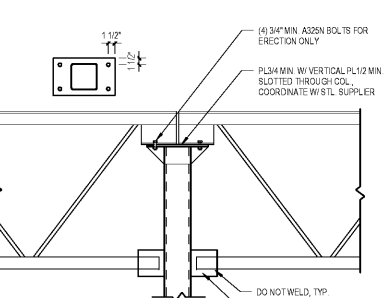

16 Framing Detail
SCALE: 3/4" = 1'-0"

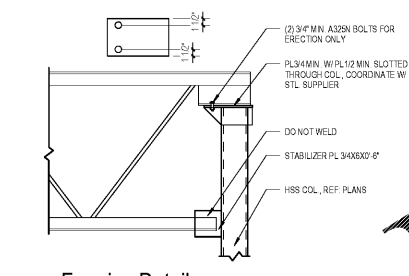

17 Framing Detail
SCALE: 3/4" = 1'-0"

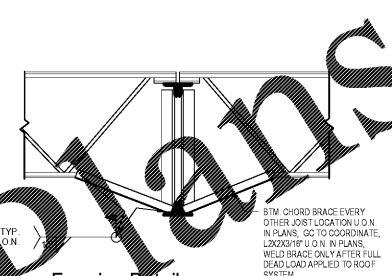

18 Framing Detail
SCALE: 3/4" = 1'-0"

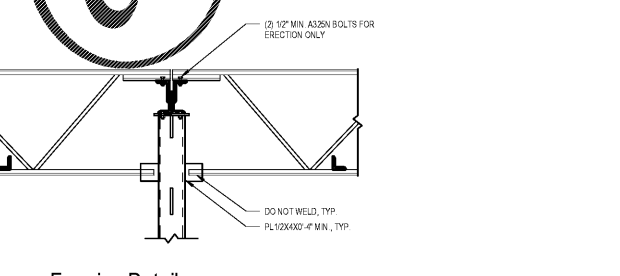

19 Framing Detail
SCALE: 3/4" = 1'-0"



20 Framing Detail
SCALE: 3/4" = 1'-0"



21 Framing Detail
SCALE: 3/4" = 1'-0"

Order Plans

1925 Prosperity Ave.
Orlando, FL 32814
P (407) 661-9100
F (407) 661-9101
www.r.p.rpk.com

Publix Retail @ Lake Crossing
South Lake Drive & Platt Springs Road
Lexington, South Carolina

WindCrest Companies
605 E. Robinson Street, Suite 340
Orlando, Florida 32801

Publix Retail @ Lake Crossing
South Lake Drive & Platt Springs Road
Lexington, South Carolina

Publix Retail @ Lake Crossing
South Lake Drive & Platt Springs Road
Lexington, South Carolina

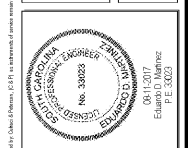

Revision Schedule	
No.	Date
A	03-31-17
B	03-21-17
C	03-15-17

S502