

2 Roof Plan
SCALE: 1" = 20'-0"

ROOF DRAINAGE CALCULATIONS

PROJECT SITE - LEXINGTON, SC 150 YEAR 1 HR RAINFALL RATE ROUNDED UP TO 4" TOTAL ROOF AREA - HORIZONTAL PROJECTED AREA PLUS AREA OF VERTICAL WALLS THAT DRAIN WATER TO THE ROOF OVERFLOW LOW DRAINAGE CALCULATED FROM TABLE 11.02.01 BY SECTION 1107.3

ROOF LABEL	TOTAL AREA	LANE	QTY	DIAMETER REQ'D	DIAMETER PROV.
A	3,319.90	2	4	4	4
B	3,363.90	2	4	4	4
C	3,319.90	2	4	4	4

ROOF DRAINAGE CALCULATIONS

HORIZONTAL PROJECTED AREA (SQUARE FEET)

DIAMETER OF LEADER (INCH)	1	2	3	4	5	6
1	3,880	960	720	575	480	
2	8,880	2,090	2,200	1,780	1,470	
3	18,400	4,220	4,150	3,200	2,670	
4	34,000	7,300	11,530	8,650	6,980	5,765
5	50,000	27,000	17,950	13,500	10,800	9,000
6	118,000	58,000	38,660	29,000	23,200	19,315

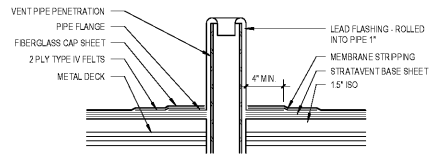

9 Roof Vent Penetration Detail
SCALE: 1 1/2" = 1'-0"

1 Roof Plan
SCALE: 1/8" = 1'-0"

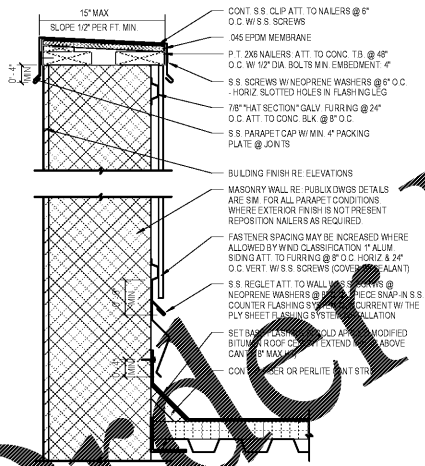

4 Parapet Detail
SCALE: 3/4" = 1'-0"

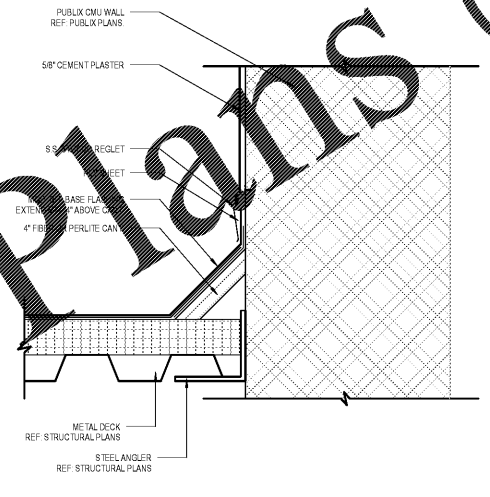

5 Parapet Detail
SCALE: 1 1/2" = 1'-0"

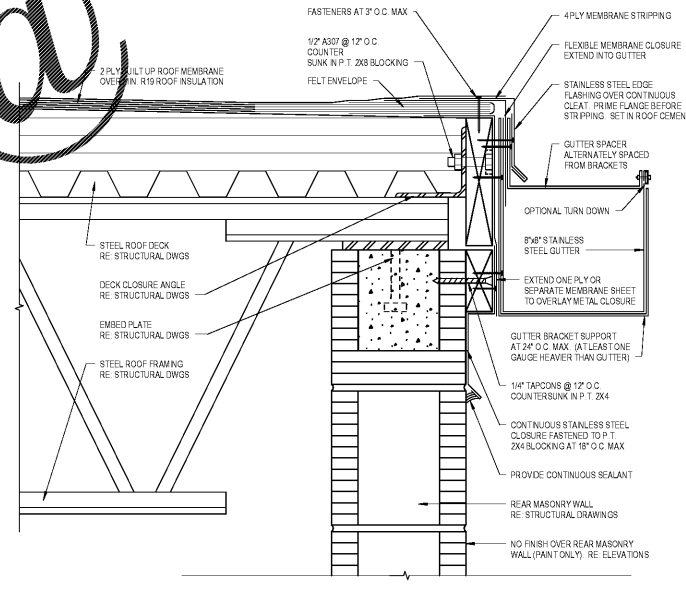

6 Rear Wall Gutter Detail
SCALE: 3" = 1'-0"

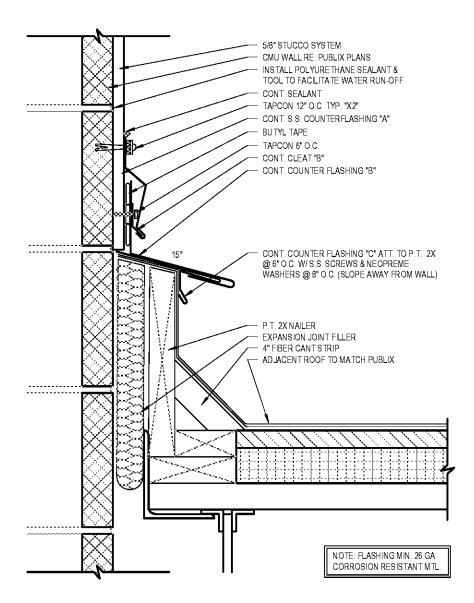

7 Expansion Joint Detail
SCALE: 3" = 1'-0"

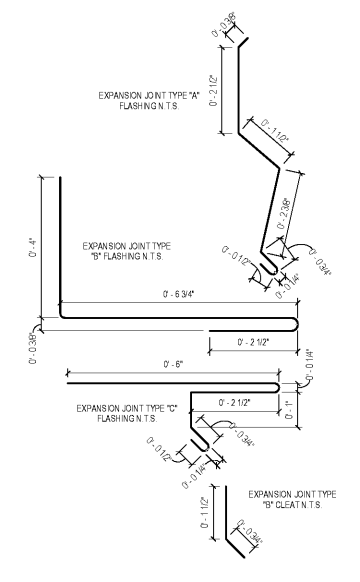

8 Cleat Detail
SCALE: 6" = 1'-0"

1925 Prospect Ave.
Orlando, FL 32814
P (407) 661-9100
F (407) 661-9101
www.r.p.a.com

Chalaci & Retam
Architects Engineers

Publix Super Markets, Inc.
3300 Public Corporate Pkwy
Lakeland, Florida

Publix/Retail @ Lake Crossing
South Lake Drive & Platt Springs Road
Lexington, South Carolina

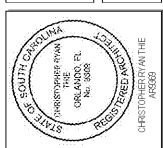

Revision Schedule

No.	Description	Date
A	100% Public Submission	03-21-17
C	100% Public Submission	08-10-17