

2'-0" STANDARD CURB AND GUTTER

NOTES:
 1. SCORE CURB / VALLEY GUTTER AT 15' O.C.
 2. PROVIDE 1/2" EXPANSION JOINTS AT 80' O.C.
 3. CONTRACTION JOINTS SHALL BE SPACED AT 10' INTERVALS. (A 15' SPACING WILL BE ALLOWED WHEN A MACHINE IS USED.)
 4. FINISH ALL CONCRETE WITH CURING COMPOUND.

2'-0" ROLLED CURB AND GUTTER

NOTES:
 1. SCORE CURB / VALLEY GUTTER AT 15' O.C.
 2. PROVIDE 1/2" EXPANSION JOINTS AT 80' O.C.
 3. CONTRACTION JOINTS SHALL BE SPACED AT 10' INTERVALS. (A 15' SPACING WILL BE ALLOWED WHEN A MACHINE IS USED.)
 4. FINISH ALL CONCRETE WITH CURING COMPOUND.

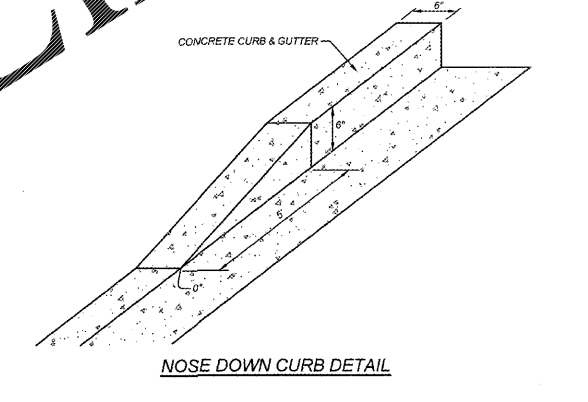
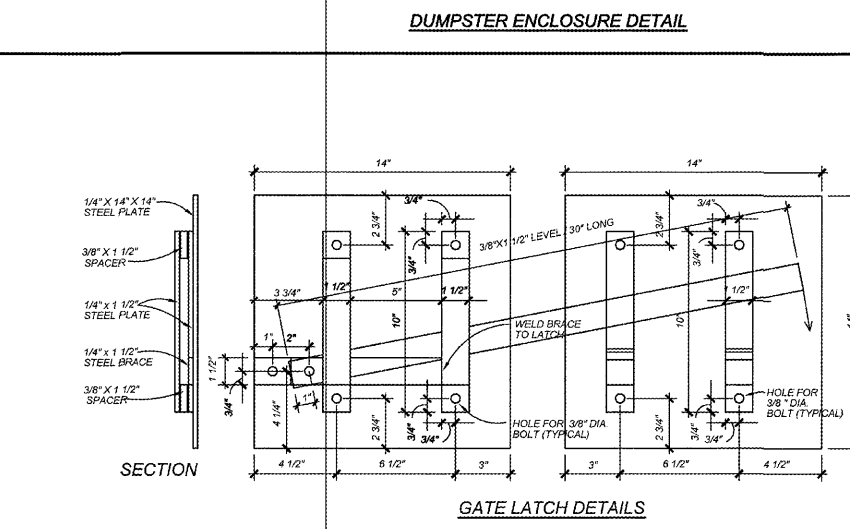
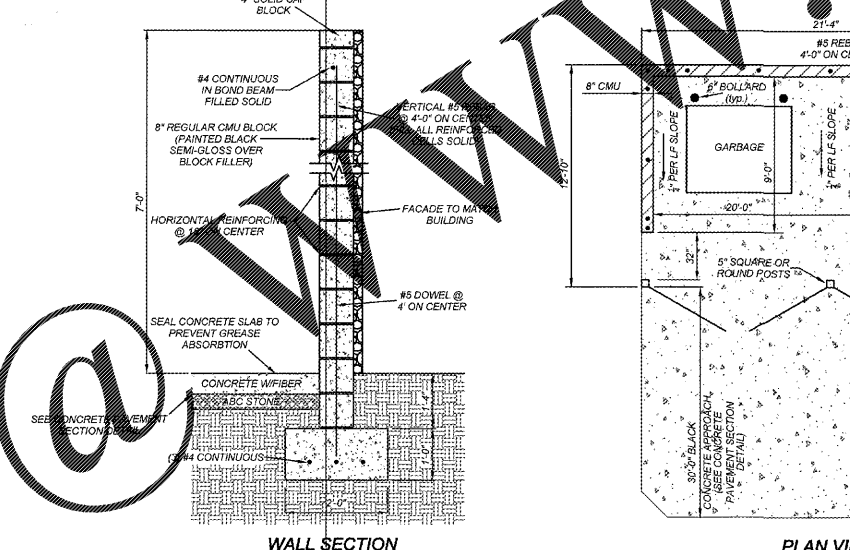
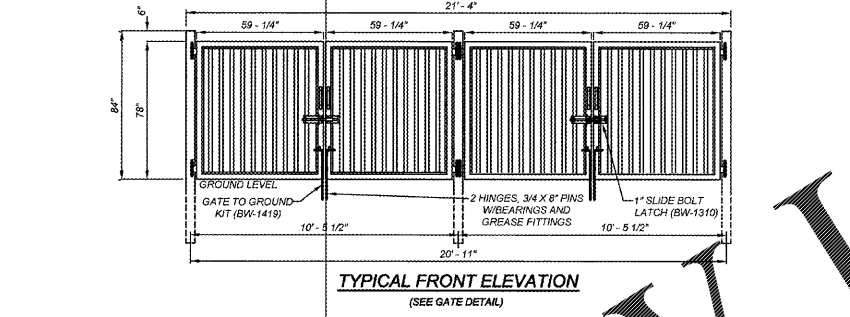
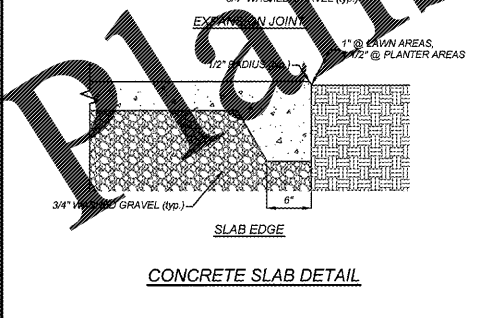
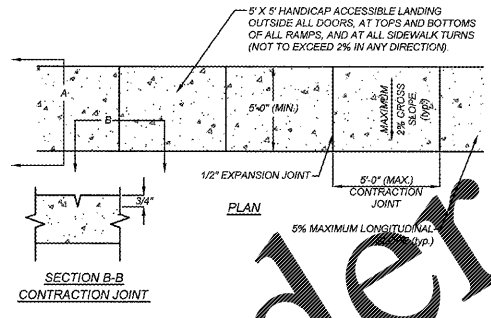
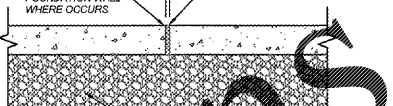
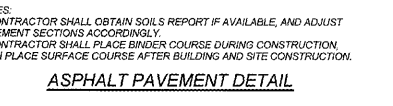
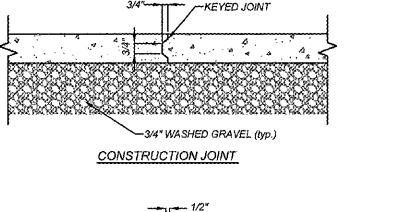
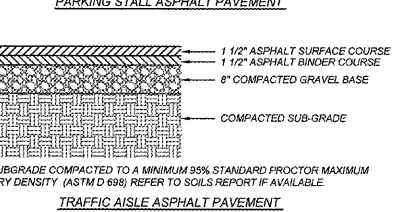
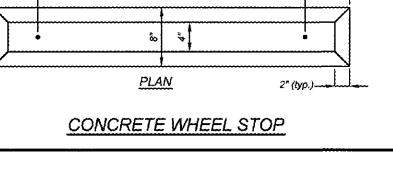
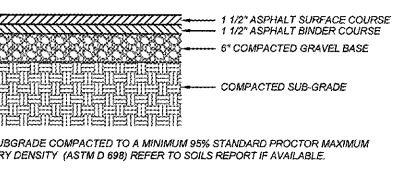
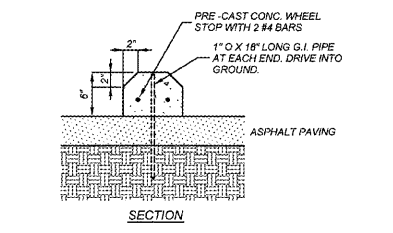
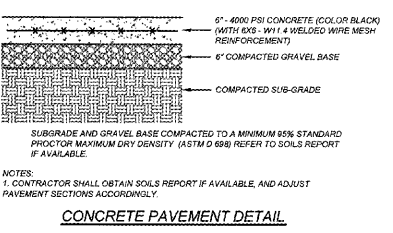

24 HOUR CONTACT
 JEREMY REAVES
 CONSTRUCTION MANAGER
 TELEPHONE: (336) 215-7025

NO.	DATE	DESCRIPTION
1	06-23-2016	REVISIONS
2	07-18-2016	REVISIONS

COMMERCIAL SITE DESIGN

882 CREEKWOOD ROAD
 RALEIGH, NORTH CAROLINA 27609

(919) 846-9201 FAX: (919) 838-2791
 WWW.CSDDESIGN.COM

CLIENT:
 COOK OUT
 15 LAURA LANE, SUITE 300
 THOMASVILLE, NC 27380
 TELEPHONE: (336) 215-1025
 FAX: (336) 474-7849

COOKOUT FRESH HAMBURGERS

2546 CHIMNEY ROCK ROAD
 HENDERSONVILLE, NORTH CAROLINA

DETAILS

PROJECT NO:	OUT-1615
FILENAME:	OUT1615-DTL1
DRAWN BY:	DFS
SCALE:	N.T.S.
DATE:	03-16-16
SHEET NO.:	C-6