

- KEYNOTES**
- 2.2 REMOVE FLOOR TILE AND SETTING BED.
 - 2.3 REMOVE CARPET/ CARPET PAD.
 - 2.4 REMOVE CONCRETE SLAB FOR NEW ELECTRICAL OR PLUMBING LINES.
 - 2.10 REMOVE VINYL WALL COVERING AND CORNER GUARDS (IF ANY). DO NOT ALLOW THE PAPER SURFACE OF THE DRYWALL TO BE TORN, PATCH AND REPAIR WALLS AS REQUIRED TO RECEIVE NEW FINISHES.
 - 2.19 REMOVE DOOR & SALVAGE DOOR HARDWARE.
 - 2.29 REMOVE DOOR, DOOR FRAME, AND SALVAGE DOOR HARDWARE.
 - 2.33 REMOVE WALL SCONES.
 - 2.35 REMOVE ALL DECORATIVE LIGHT FIXTURES.
 - 2.36 REMOVE WINDOW TREATMENTS.
 - 2.37 REMOVE BASE.
 - 2.82 REMOVE LIGHT FIXTURES AND PREPARE TO REPLACE.
 - 2.83 REMOVE COUNTERTOPS AND PREPARE TO REPLACE.
 - 2.85 RETURN EQUIPMENT TO OWNER.
 - 2.96 REMOVE SHELF AND SUPPORTS.
 - 2.97 REMOVE COUNTERTOP AND SUPPORTS.
 - 6.7 PROVIDE NEW VANITY COUNTERTOP. REFER TO DETAILS.
 - 8.2 INSTALL NEW LIGHTED MIRROR.
 - 8.3 PROVIDE NEW DOOR, DOOR FRAME, AND HARDWARE.
 - 9.1 PROVIDE NEW TILE AND SETTING BED.
 - 9.3 PROVIDE NEW THRESHOLD.
 - 9.4 NEW VINYL WALL COVERING.
 - 9.5 PAINT CEILING.
 - 9.7 PAINT WALLS. REFER TO FINISH PLAN. GC TO VERIFY PRESERVE OF ORANGE PEEL TEXTURE. PROVIDE ORANGE PEEL TEXTURE AS NECESSARY.
 - 9.19 PREP AND PAINT EXISTING BASEBOARD TRIM.
 - 9.27 PROVIDE NEW BASE.
 - 9.32 SKIM COAT CEILING FOR SMOOTH SURFACE.
 - 10.3 PROVIDE NEW TOILET ACCESSORIES.
 - 10.4 PROVIDE NEW TOILET PARS.
 - 10.7 INSTALL NEW TOILET PARS.
 - 10.8 PROVIDE NEW ART. AND HARDWARE TO TOILET PARS.
 - 22.1 PROVIDE NEW TOILET PARS TO PLUMBING DRAWINGS.
 - 22.4 PROVIDE NEW VANITY PLUMBING LINES.
 - 22.5 PROVIDE NEW FAUCET. REFER TO PLUMBING DRAWINGS.
 - 26.1 PROVIDE NEW FUNCTION LIGHT OR LIGHTED MIRROR, CONNECT TO EXISTING SWITCH.
 - 26.2 PROVIDE NEW (8" LIGHT) EXHAUST FAN COMBO.
 - 26.4 ACCEPTANCE. REFER TO ELECTRICAL DRAWINGS.
 - 26.5 INSTALL NEW WALL SCONES.
 - 26.8 PROVIDE NEW RECESSED DOWN LIGHT.
 - 26.11 NEW DECORATIVE LIGHT FIXTURE.

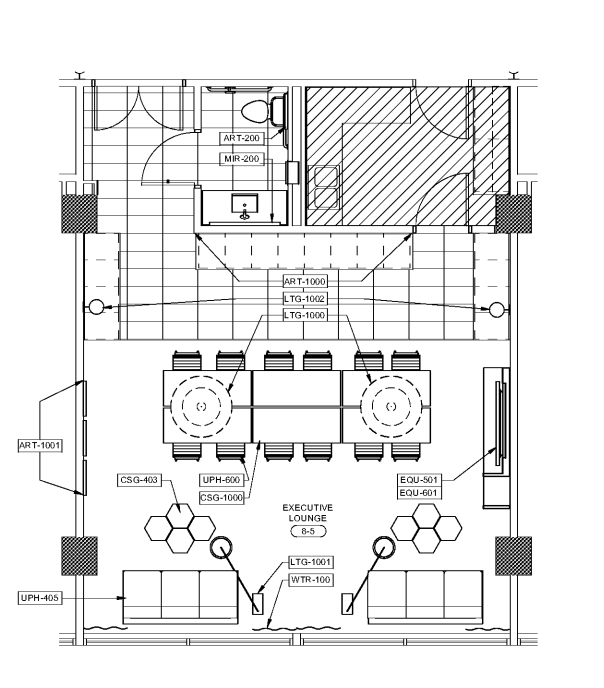
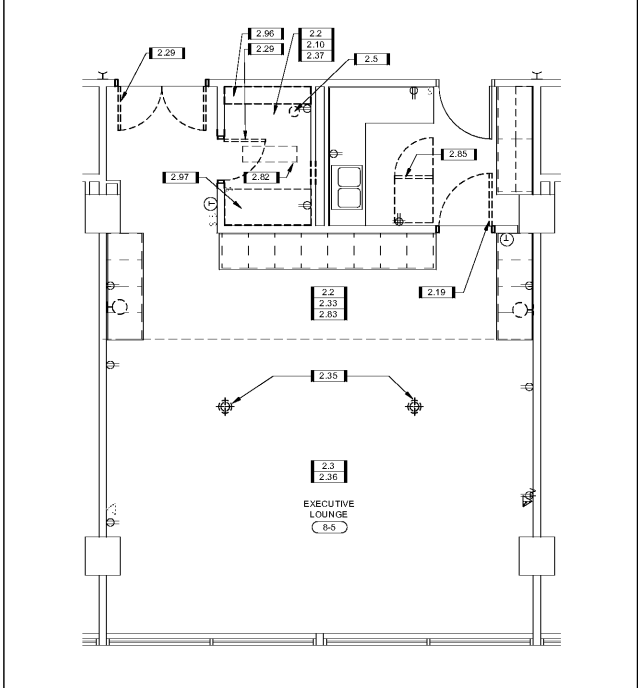
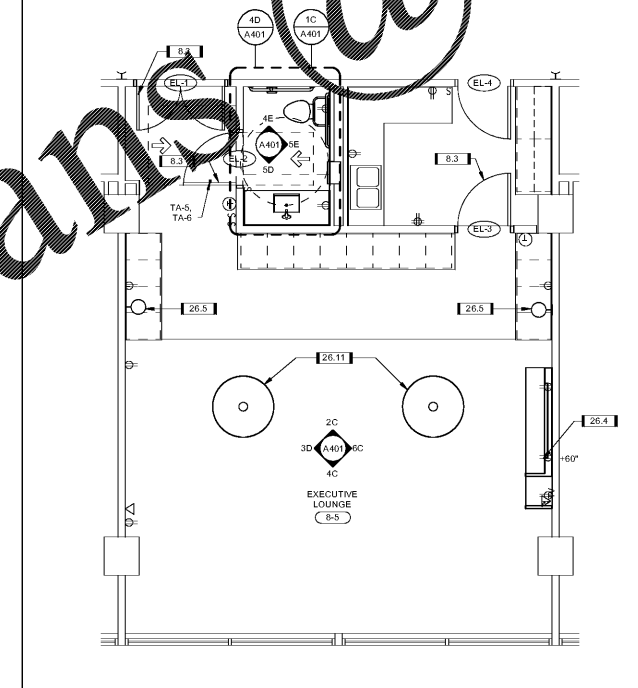
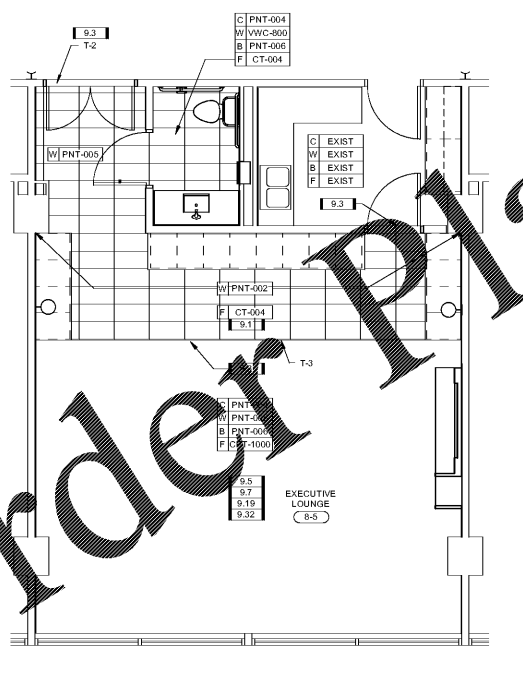
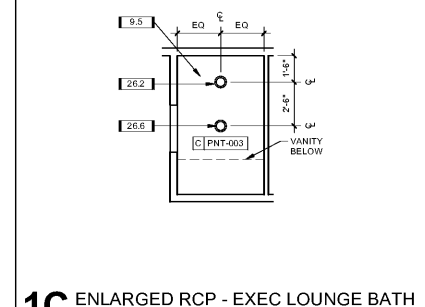
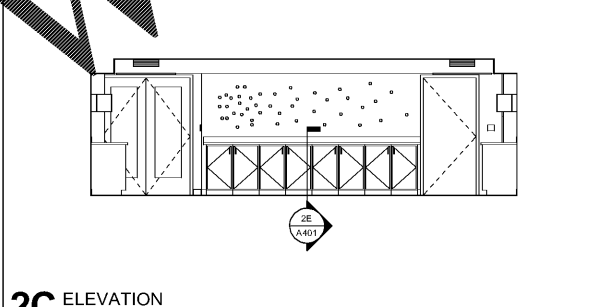
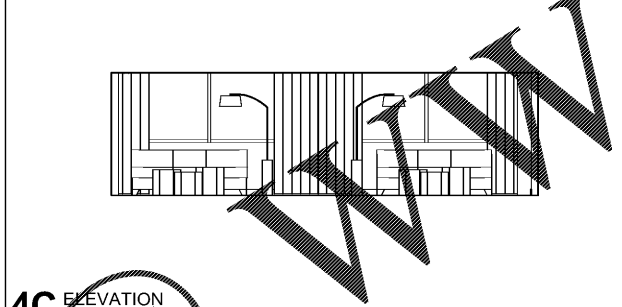
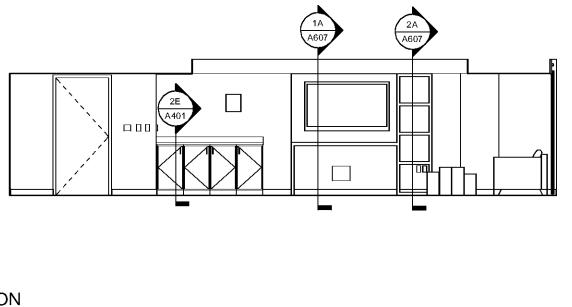
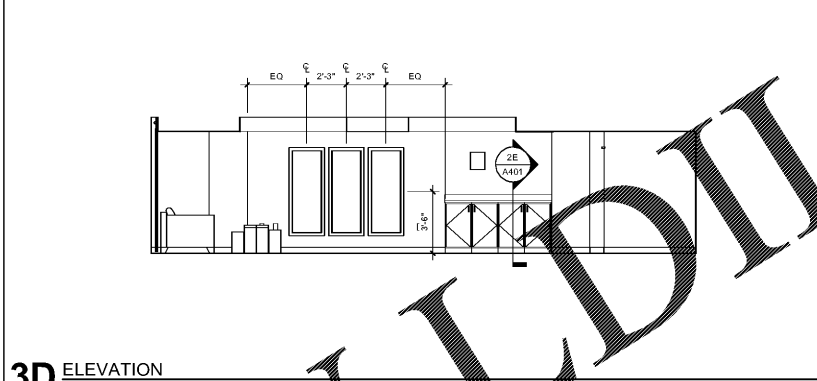
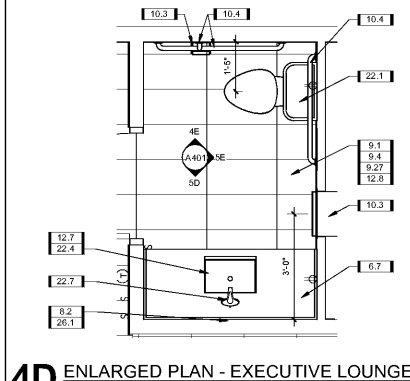
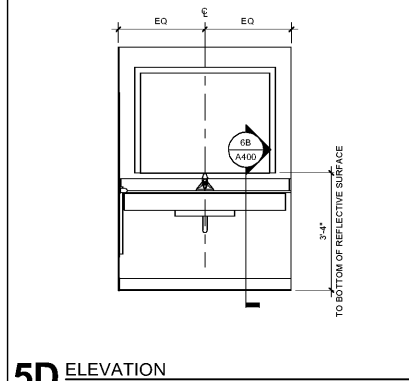
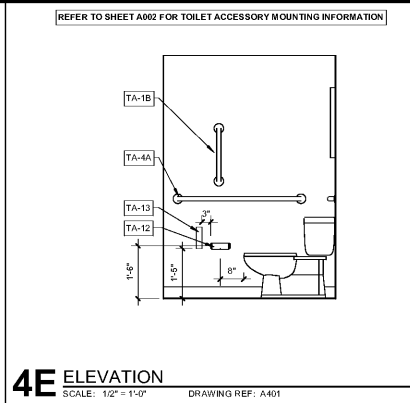
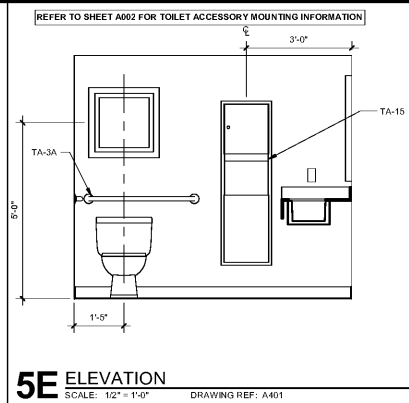
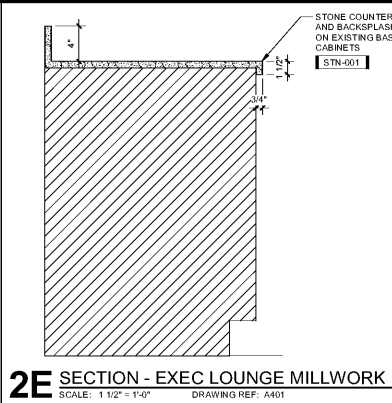

ISSUE: 6/12/2017 - CONSTRUCTION SET

DRAWING TITLE: ENLARGED PLAN - EXECUTIVE LOUNGE

DRAWING NO.: A401

Order Plans @

WWW.LDMLINE.COM