

9 UNLEADED/DIESEL DISPENSER ELEVATION  
NTS

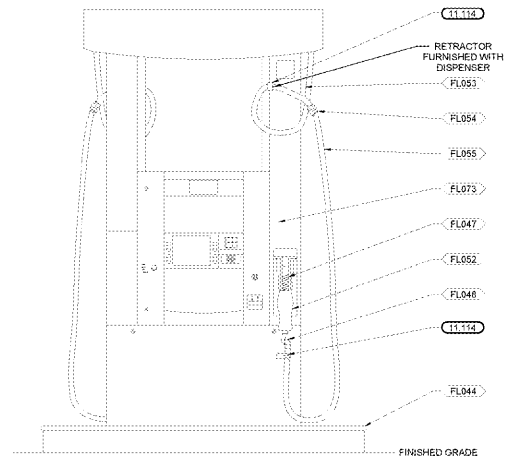

8 UNLEADED DISPENSER ELEVATION  
NTS

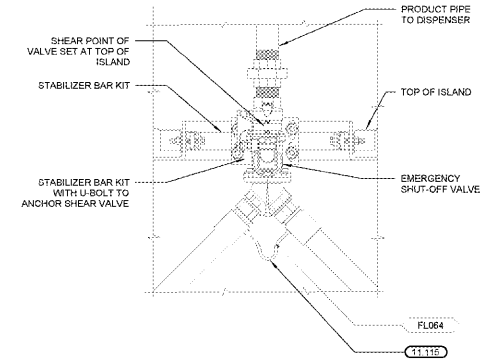

7 SHEAR VALVE PLACEMENT DETAIL  
NTS

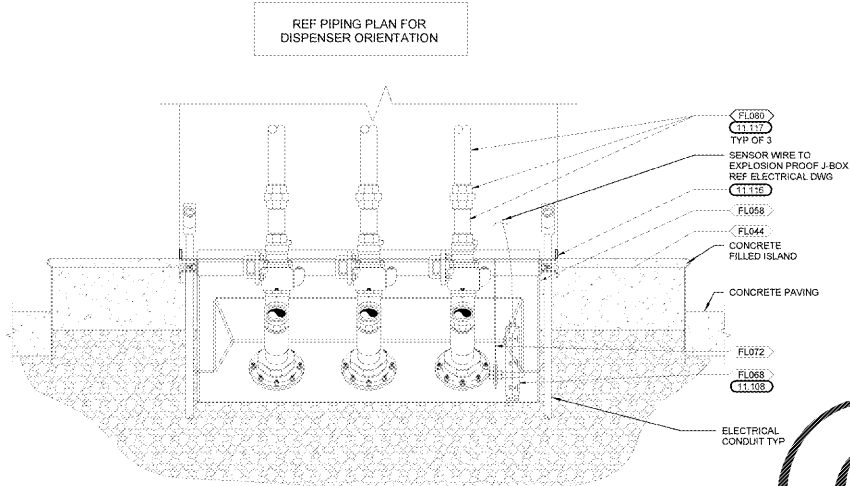

5 UNLEADED/DIESEL DISPENSER SUMP SECTION  
NTS

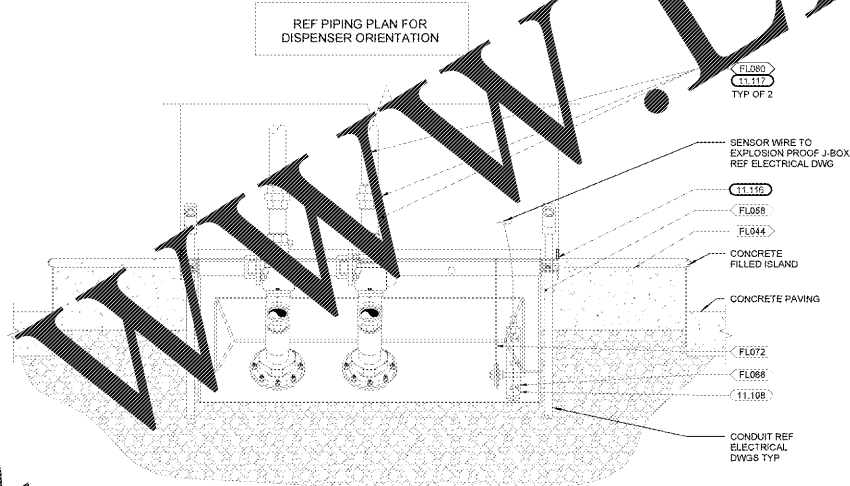

4 UNLEADED DISPENSER SUMP SECTION  
NTS

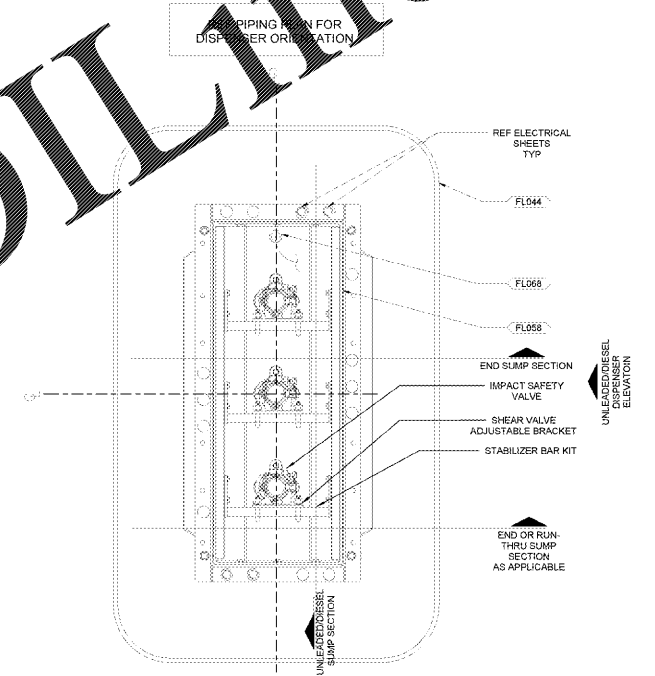

6 UNLEADED/DIESEL DISPENSER PIPING PLAN  
NTS

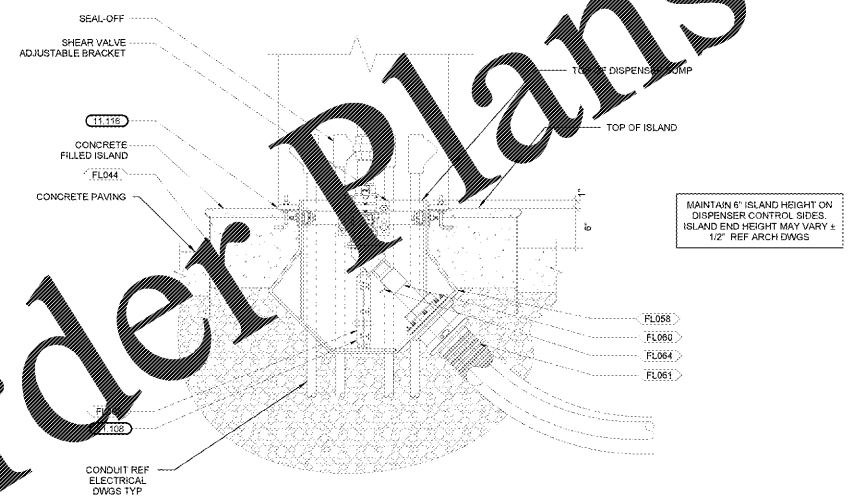

3 END DISPENSER SUMP SECTION  
NTS

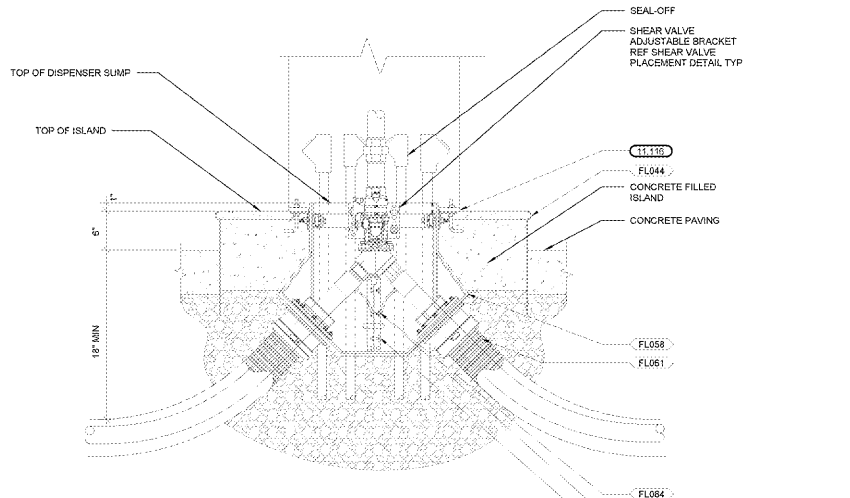

2 RUN-THRU DISPENSER SUMP SECTION  
NTS

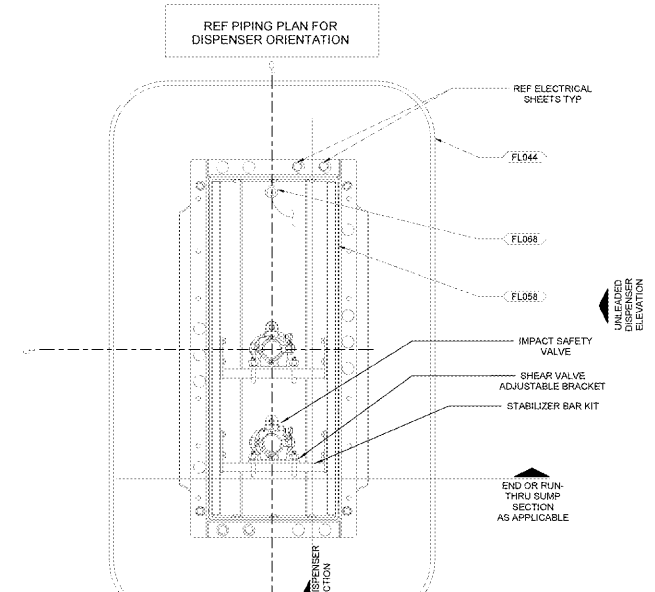

1 UNLEADED DISPENSER PIPING PLAN  
NTS

**KEYNOTES**

- 11.108 SLUMP SENSOR TO REST ON THE LOWEST POINT OF SLUMP ENCLOSURE. SECURE SENSOR USING MANUFACTURERS UNIVERSAL MOUNTING KIT
- 11.114 INSTALL ALL WARNING DECALS FURNISHED FOR DISPENSER AND NOZZLES. INSTALL RETRACTORS SUPPLIED WITH DISPENSERS. ATTACH RETRACTORS TO HOSES WITH CONTRACTOR FURNISHED 3/8" MODEL 8193 CLAMPS.
- 11.115 REMOVE AIR CHUCK VALVE AFTER TESTING. REMOVE THE TEST TUBE AND LEAVE IN SLUMP AFTER COMPLETING TEST.
- 11.116 SEAL CONNECTION BETWEEN DISPENSER AND DISPENSER SLUMP WITH CALK OR IMPERVIOUS STRIPPING.
- 11.117 1 1/2" PRODUCT RISER PIPE TO DISPENSER.

STIPULATION FOR THE USE OF THIS DOCUMENT IS LIMITED TO THE PROJECT AND SITE SPECIFICALLY IDENTIFIED IN THE PROJECT DESCRIPTION. ANY REUSE OR MODIFICATION OF THIS DOCUMENT WITHOUT THE WRITTEN CONSENT OF THE ENGINEER IS STRICTLY PROHIBITED. THE USER ASSUMES ALL LIABILITY FOR THE USE OF THIS DOCUMENT.

**MPW**  
MPW ENGINEERING, LLC  
1001 S. UNIVERSITY AVENUE, SUITE 100  
APOPKA, FL 32703  
TEL: 407.884.1000  
WWW.MPWENGINEERING.COM

**Walmart**  
APOPKA, FL  
STORE NO. 0884  
09/15/06 | PHOTO

**ISSUE BLOCK**

NO.	DESCRIPTION	DATE

CHECKED BY: MMW  
DRAWN BY: TDT  
FILE NAME: PST4  
PROTO CYCLE: 02/10/17  
DOCUMENT DATE: 04/07/17

**BID SET.  
NOT FOR  
CONSTRUCTION**

THIS ITEM HAS BEEN ELECTRONICALLY SIGNED AND SEALED BY SCOTT C. WEBB. PE ON THE DATE AND/OR TIME STAMP SHOWN USING A DIGITAL SIGNATURE. PRINTED COPIES OF THIS DOCUMENT ARE NOT CONSIDERED SIGNED AND SEALED AND THE SIGNATURES MUST BE VERIFIED ON ANY ELECTRONIC COPIES.

**DISPENSER AND SUMP DETAILS**

SHEET: **FST4**

Order Plans @

WWW.LDILINE.COM