

SHEET NOTES
 1. ROOFING SYSTEM AND MANUFACTURER SHALL MATCH THE SYSTEM USED AT THE BUILDING.
 2. REF. 8-FSA4 FOR FLASHING AT ROOF PENETRATIONS
 3. PROVIDE HEAVY DUTY HOLD DOWN CLIPS AT ALL CEILING TILE

WALMART
 STORE NO: 8894-00
 APOLKA, FL
 997-61-0061 | PHOTO
 WMMB-740R

STIPULATION FOR THE ROOFING CONTRACTOR TO BE ADVISED THAT THE ROOFING CONTRACTOR SHALL BE RESPONSIBLE FOR OBTAINING ALL NECESSARY PERMITS AND APPROVALS FROM THE LOCAL AUTHORITY. THE ROOFING CONTRACTOR SHALL BE RESPONSIBLE FOR OBTAINING ALL NECESSARY PERMITS AND APPROVALS FROM THE LOCAL AUTHORITY. THE ROOFING CONTRACTOR SHALL BE RESPONSIBLE FOR OBTAINING ALL NECESSARY PERMITS AND APPROVALS FROM THE LOCAL AUTHORITY.

CONSULTANTS

Walmart
Apopka, FL
 STORE NO: 8894-00
 997-61-0061 | PHOTO
 WMMB-740R

ISSUE BLOCK

CHECKED BY: MMA
 DRAWN BY: MMA
 FILE NAME: 740R-FSA4
 PHOTO CYCLE: 021017
 DOCUMENT DATE: 04/07/17

BID SET NOT FOR CONSTRUCTION

ROOF PLAN RCP AND DETAILS

SHEET: FSA4

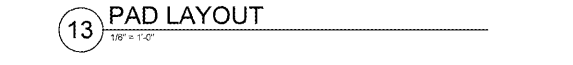
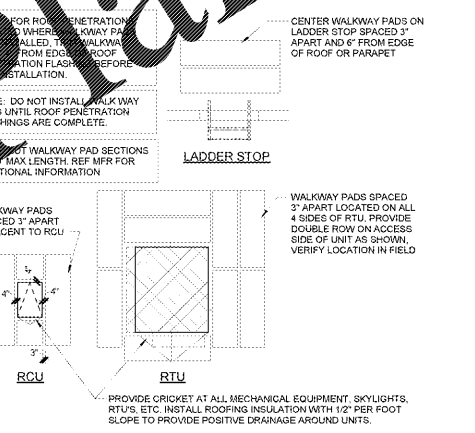
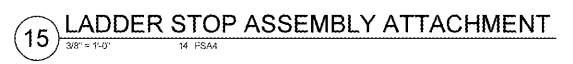
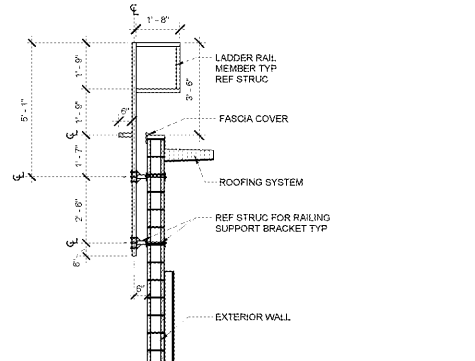
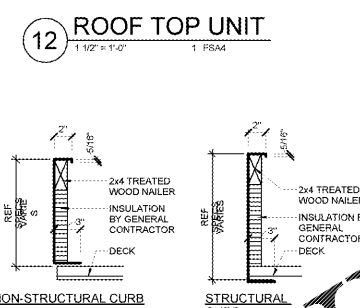
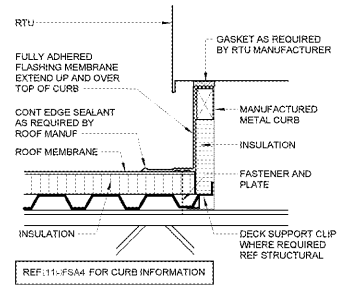
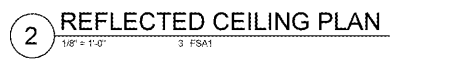
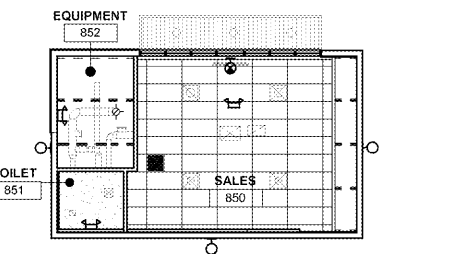
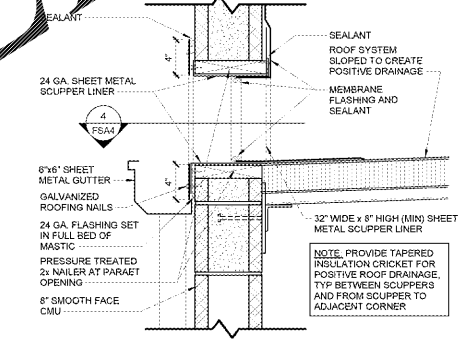
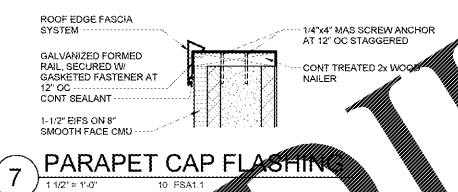
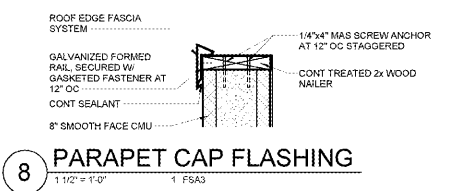

Order Plans

DATE: 04/07/17