

Order Plans @ [www.WWW.com](http://www.WWW.com)

11 PRECAST CONC WATER TABLE  
3' x 1'-0"

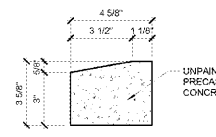

10 JAMB  
1 1/2" x 1'-0"

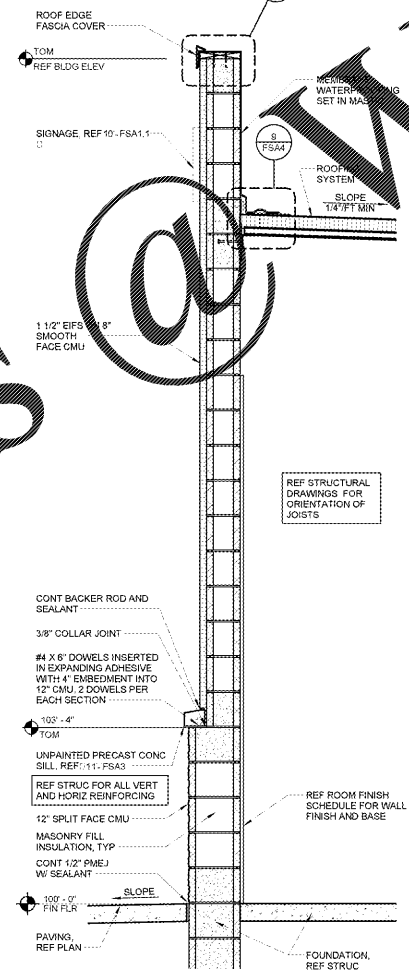

12 WALL SECTION  
3/4" x 1'-0"

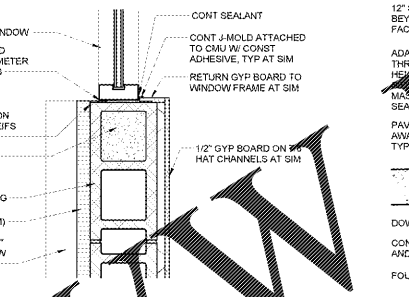

6 THRESHOLD  
1 1/2" x 1'-0"

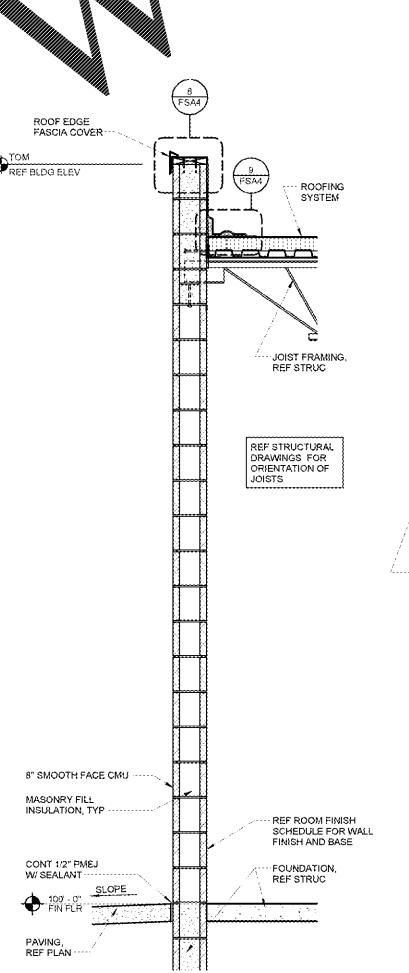

9 WALL SECTION  
3/4" x 1'-0"

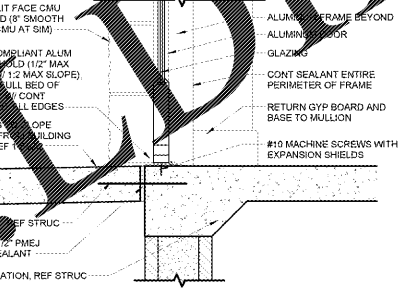

7 JAMB  
1 1/2" x 1'-0"

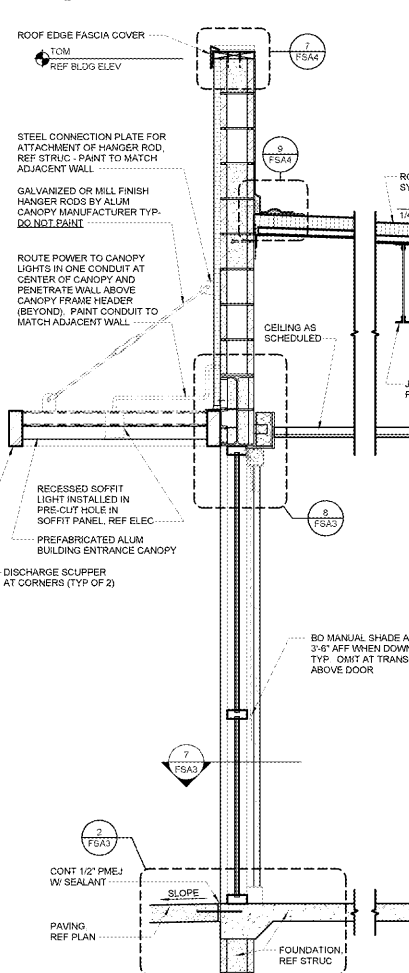

5 WALL SECTION  
3/4" x 1'-0"

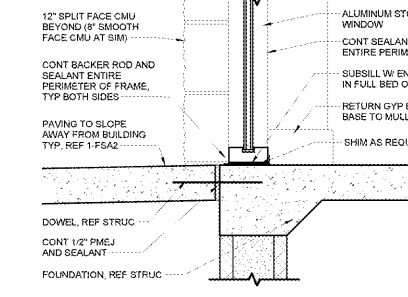

3 JAMB  
1 1/2" x 1'-0"

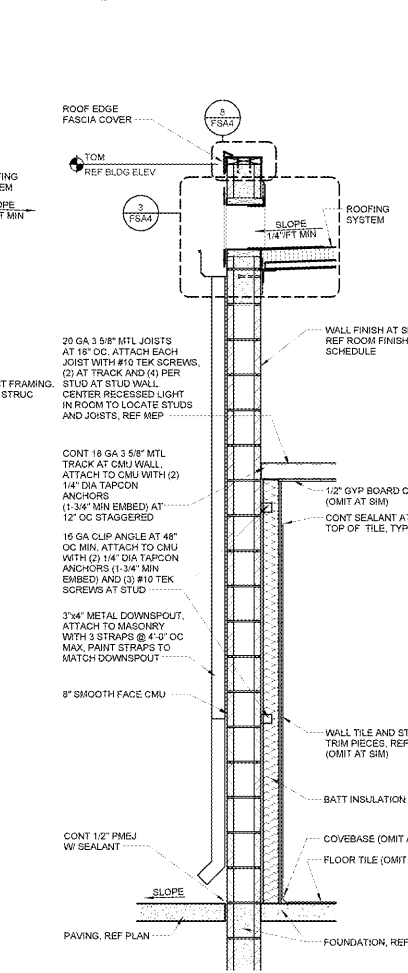

1 WALL SECTION  
3/4" x 1'-0"

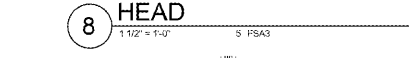

8 HEAD  
1 1/2" x 1'-0"

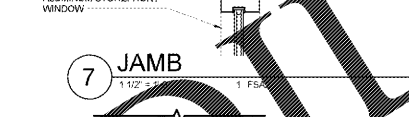

4 HEAD  
1 1/2" x 1'-0"



2 THRESHOLD  
1 1/2" x 1'-0"

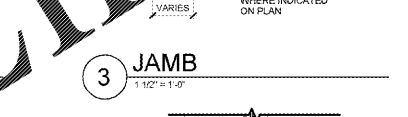

3 JAMB  
1 1/2" x 1'-0"

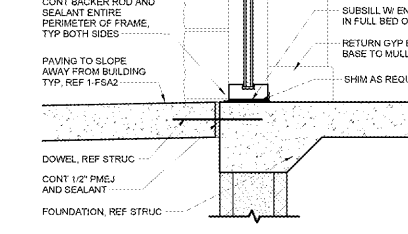

4 HEAD  
1 1/2" x 1'-0"

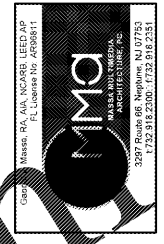

Walmart  
Apopka, FL

Walmart  
Apopka, FL  
STORE NO: 6804-00  
JOB NUMBER: 097-16-006

ISSUE BLOCK

NO.	DATE	DESCRIPTION

CHECKED BY: MMA  
DRAWN BY: MMA  
FILE NAME: 740R-FSA3  
PROTO CYCLE: 021017  
DOCUMENT DATE: 04/27/17

BID SET  
NOT FOR  
CONSTRUCTION

WALL  
SECTIONS  
AND DETAILS

WALMART  
FSA3